

USER'S MANUAL (Product Number: 3DA)

Thank you for purchasing PIVOT product.
Please read this manual carefully and keep it for future reference.

If this product is given to another user, make sure to include this User's Manual.

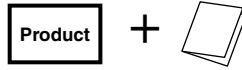

Cruise & Throttle for Full Control:
Acceleration, Deceleration and Resume

3 drive · α THROTTLE & AUTO CRUISE

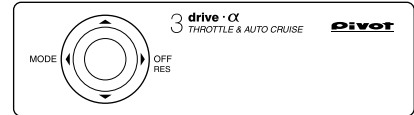

Contents

Before Using	1-2	procedure 3 Initial Settings (Degree of Acceleration Setting)	7
Contents	2	procedure 4 Speed Pulse Settings	8
Product Features	2-3	Test Drive	8
Features	2	Basic Operation	8
Part Names / Display Items	3	How to Operate	9-11
WARNING / CAUTION	3	Operating the Throttle Controller	9
procedure 1 Connecting The Wires	4-5	Operating the AUTO CRUISE	
Brake Switch	4	Set / Deactivate / Change the Speed Setting	10
Car Speed Signal / Earth / Reverse Signal /		Resume / Adjust Level	11
Specialized Harness	5	Troubleshooting	11-12
procedure 2 Installing The Product	6		



After installation, make sure to carry out “Initial Settings”.

After having installed this product, make sure to make settings for your car's special characteristics by carrying out the “Initial Settings” on Page 7. If the “Initial Settings” are not carried out, a **Check Engine Light** may go on. Also, the unit will remain in **NORMAL Mode** even if the Mode is switched.

Worried about Installation?

If you are worried about carrying out wiring or other installation procedures please consult your dealer.

Only use 3-drive Specialized Harness.

Using another type of harness will cause troubles and failure; use only the 3-drive specialized harness.

This product can not be installed in car models which come with standard auto-cruise control.

Set to NORMAL Mode upon Removal of Product.

When uninstalling the product, make sure to return it to **nor** (NORMAL) Mode before carrying out any work. Reconnecting this product in a different mode may cause the Check Engine Light to come on.

Modifying this Product is Forbidden.

Under no circumstances should modifications or changes be made to this product. Doing so may cause damage not only to the product, but to the car and the operation of the car in which it is installed.

Before Using

Features

Connecting The Wires

Installing The Product

Initial Settings

Speed Pulse Settings

How to Operate

Trouble-Shooting

Please check the contents of the package

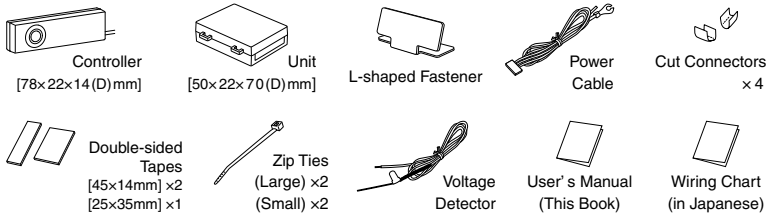

Tools and Materials to prepare for installation

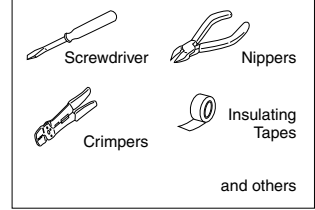

Features

Cruise & Throttle for Full Control: Acceleration, Deceleration and Resume!

AUTO CRUISE



Cruise & Throttle for Full Control: Acceleration, Deceleration and Resume Can operate the switches for **SET**, **Acceleration**, **Deceleration**, **Resume**, and **Deactivate**.

Performance Control Advancements made have improved on speed stability.

Safety Safety First Design including instant deactivation upon braking.

Settable Speed 30–140km/h

Change Speed Setting Use the product's switch or car's accelerator pedal to change speed setting. (Each press of the switch changes setting by 2km/h, or hold down switch to make larger changes)

Comparison of Fuel Consumption

Run in AUTO CRUISE	(60 km/h)	121 cc
Variable Speed Driving using Accelerator 1	(55–65 km/h)	151 cc
Variable Speed Driving using Accelerator 2	(50–70 km/h)	183 cc

These figures were obtained through a driving test and may be different from results on actual road conditions.

• WAGON R (MH23S) / Road grade: Upward slope of approx. 1.5 degrees / Running distance: 1.5 km

Note: Variable speed driving was obtained by accelerating up and down around the set speed.

THROTTLE CONTROLLER



SPORTS & ECO Accelerator response can be adjusted to one of three modes (12 steps): SPORTS (7 steps), ECO (5 steps), and NORMAL.

Acceleration Monitor Open times of the accelerator (amount of depressing) are displayed and it is convenient for the Eco-driving etc.

Comparison of Fuel Consumption

Normal	107 cc
SP7	157 cc
Ec5	58 cc

Comparison of Acceleration Time

Normal	23 sec
SP7	19 sec
Ec5	29 sec

SP7: MAX. SPORTS Mode Ec5: MAX. ECO Mode

• HONDA STEP WGN (RG1) / Running distance: 0–400 m / Degree of acceleration: 30%

Examples of Changes in Throttle Opening

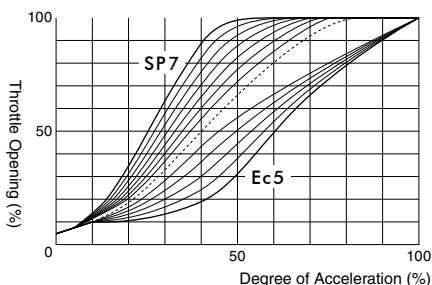

SP7: MAX. SPORTS Mode Ec5: MAX. ECO Mode

----- NORMAL

• SUZUKI SWIFT (ZC31S)

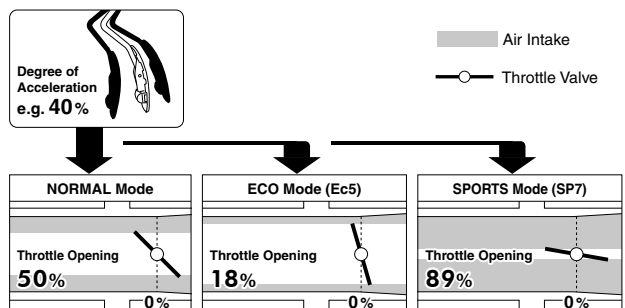

Note: In some car models with a Valvematic engine, control is carried out by the exhaust valve rather than the throttle valve.

Part Names

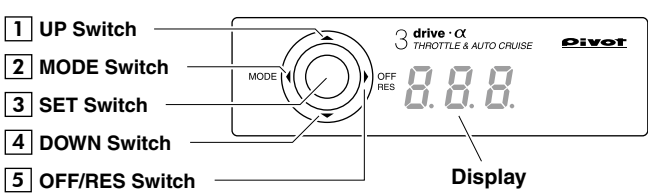

Turning off the Display

This product is interlocked with the ECU (engine computer) power. Depending on the model of car, the display may remain on for up to 15 minutes even after the ignition has been turned to the OFF position; this is normal.

No.	AUTO CRUISE OFF	Driving in AUTO CRUISE
1	Adjusting the Change Ratio for each Mode	Raise speed setting
2	For Switching Modes Alarm Sound ON/OFF	Adjusting Level
3	Set AUTO CRUISE	Re-set to current speed
4	Adjusting the Change Ratio for each Mode	Lower speed setting
5	Resume AUTO CRUISE	Deactivating AUTO CRUISE

Display Items

Display	Details
SP1 - SP7	SPORTS Mode (higher number = higher response)
Ec1 - Ec5	ECO Mode (higher number = lower response)
nor	NORMAL (Normal Performance)
A00	Degree of Acceleration
Rcc	AUTO CRUISE in Operation
H / Lo	Raise and lower AUTO CRUISE speed setting
rES	Resuming AUTO CRUISE
bAc	Reverse (when in SPORTS Mode only)
- - -	Cancel AUTO CRUISE (car speed)
- b -	Cancel AUTO CRUISE (brake)

Display for Settings

Display	Details
cAr	Initial Settings Mode
L00	Position when accelerator is not pressed down
H00	Position when accelerator is fully pressed down
SEt	Settings Completed
PLS	Speed Pulse Setting Mode
P00	Speed Pulse Number
L - 0	Adjust AUTO CRUISE Level
on/off	Alarm Sound ON/OFF

WARNING

Improper use or disregard of these warnings may result in the injury or death of people.

- When making initial settings make sure to stop the engine and place in Parking or Neutral. It is dangerous to carry out these settings while the engine is running.
- Do not work in areas where there is excessive exhaust. Due to vehicle exhaust emission poisoning or fire may result in a damage to humans.
- Do not crush the cable. Please be careful that the cable does not get crushed by the seat rail or car door steel plate, nor cut by any sharp steel plate as this may cause a poor connection or an electric short leading to fire or other danger.
- While driving DO NOT operate switches or pay prolonged attention to the display; it is extremely dangerous.
- Make sure that all wiring and fastening down of the product does not interfere with driving nor be done in such a way as to cause poor connections.

CAUTION

Improper use or disregard of these warnings may cause injury to persons, damage the product and/or other things.

- PIVOT Corporation accepts no responsibility, in any manner whatsoever, for damage and/or trouble to your vehicle or product, nor for any accidents that are the result of the misuse of this product.
- Please confirm that the type of vehicle you wish to install into is listed in the "List of Specialized Harnesses by Car Model for 3-drive · α".
- When installing this product, we recommend that if technical knowledge becomes necessary please consult a qualified mechanic.
- If the device is improperly installed or settings have been improperly made a Check Engine Light may go on.
- Do not use electrotrap.
- Wiring should be carried out using the attached "cut connector" or by soldering, make sure to securely insulate all wiring parts with insulation tape, and confirm that no wires are sticking out.
- Please wipe with a soft dry cloth (a lens cloth).
- Please do not use alcohol or benzene. This may cause damage to the painted surface or cracks in the plastic.
- Do not, in any manner, process, take apart, or make changes to this product.

procedure 1

Connecting The Wires

Basic Wiring When installing make sure to use the correct Specialized Harness for your car model.

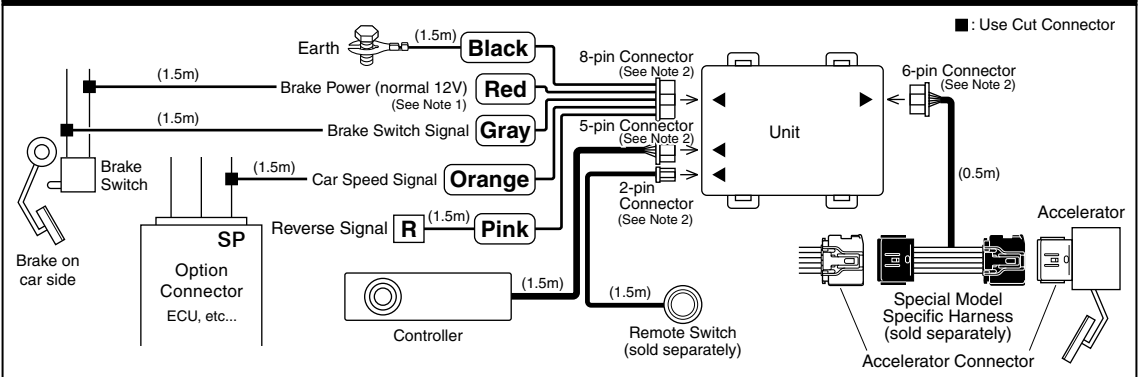

Note 1: Please make sure to connect the red cable to the brake switch, to cause auto-cruise to be deactivated when there is trouble with the car fuses.
 Note 2: After inserting the connector, pull lightly to make sure that it is securely locked.

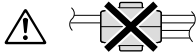

• When connecting to the car side wires, do not only use “electrotap” as this may result in a poor electrical connection. Please use the supplied “cut connectors” or solder the wires together and make sure to use insulation tape to securely insulate the wire connection.

- The Brake Switch Connectors will differ depending upon the car model, grade and year, so please sure to check the design in the “Wiring Chart”.
- Remove the battery cables from the minus terminals before carrying out the wiring.

Brake Switch (Brake Power and Brake Switch Signal)

Red To Brake Power (normal 12V)

Gray To Brake Switch Signal

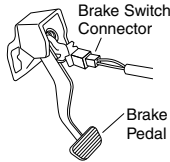

- There may be two or four (or more) wires coming from the Brake Switch Connector. Check the wiring position in the “Wiring Chart” and after testing the voltage, carry out the wiring.
- After having completed the wiring confirm that the Brake Lamp is working properly.

For a Two-Wire Connector

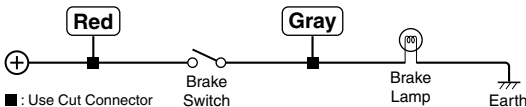

For a Four(or more)-Wire Connector

When there are four (or more) wires, do not wire to positions A and B as shown below. (See below for how to check the voltage for each wiring position)

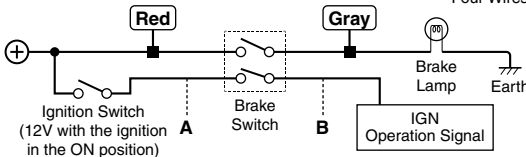

How to Test (Refer to page 5 [Reference 1] “How to use the Voltage Detector”)

1. Turn the ignition to OFF. Please put gear into P (Parking) or N (Neutral).
2. Check the terminal for each of the connections as designated in the separate sheet “Wiring Chart”.

The Wire color of the product	Not Press Down on Brake Pedal	Press Down on Brake Pedal	
Red	● (12V)	● (12V)	Brake Power
Gray	○ (0V)	● (12V)	Brake Switch Signal

● Voltage Tester Lamp ON ○ OFF

Note: If there are four (or more) wires, do not wire the remaining (OFF 0V).

Select a Wiring Method

Select from either “Connect Directly” or “Connect using Brake Harness” and carry out directions as stated.

1. After having tested voltage at the positions to be wired, connect as directed.
2. In case of the car model which is blank of Wire Numbers or Brake Harness Connection Color of “Wiring Chart”, please make sure to carry out a voltage test and connect as directed.

Connect Directly

Connect the Red and Gray wires to the corresponding wire numbers found in the “Wiring Chart” using Cut connector which is included.

(Refer to page 5 [Reference 2] “How to use the Cut Connectors”)

⚠ Note that the colors listed in the chart under “Brake Harness Connection Color” are not the colors of the wires on the car side.

e.g.) TOYOTA ALPHARD (from May 2008)

TOYOTA

車名	年式	ブレーキハーネス品番	直接接続		ブレーキハーネス接続色		Connection Numbers
			接続番号	製品のコード色	接続色	接続色	
アルファード・ヴェルファイア	H20.5~	BR-1	①	②	赤	灰	青 黄

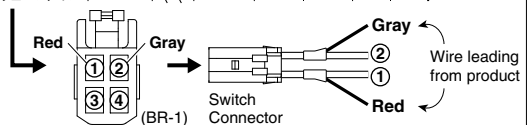

Connect Using Brake Harness (sold separately)

Connect the Red and Gray wires to the corresponding wire colors found in the “Wiring Chart”.

(For more details, please refer to the brake harness manual.)

e.g.) TOYOTA ALPHARD (from May 2008)

TOYOTA

車名	年式	ブレーキハーネス品番	直接接続		ブレーキハーネス接続色		Connection Colors
			接続番号	製品のコード色	接続色	接続色	
アルファード・ヴェルファイア	H20.5~	BR-1	1	2	赤	灰	青 (黄)

Car Speed Signal

Orange

Confirm the positions on the "Wiring Chart" and then connect using Cut Connectors.

(Refer to [Reference 2] "How to use the Cut Connectors" below.)



Note: Some MITSUBISHI, SUZUKI and NISSAN models require a separate speed pulse adapter.
Connect only to the cables on the car side as directed.
(Do not wire the speed signal to the CAN-BUS adaptor.)

Earth

Black

with earth terminal

Fasten to a screw of a metal part which is earthed.



Note: Painted screws and screws connected to plastic parts are not earthed; make sure to connect only to a place which is earthed.

Reverse Signal

By wiring to reverse, it is possible when in SPORTS Mode to automatically switch to NORMAL Mode when the gear is put into **R** (Reverse). Also, during this time it will become impossible to set to AUTO CRUISE.

Note: When put into reverse, the degree of acceleration is small and quick acceleration will not occur; it is not necessary to wire for reverse. This does not operate when in ECO Mode or NORMAL Mode.

Pink

• Gear Position

When in **R** (Reverse) = 12V, other positions = 0V

(How to Test) With the ignition in the ON position (engine not operating) put gear into reverse.

(How to Wire) Cut the black tube of the wire tip and connect referring the diagrams below.

■ If wiring to the Reverse Signal

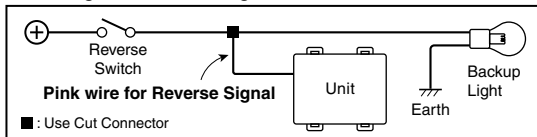

■ If wiring to the optional connector of the car maker's original navigation system

When using a different company's navigation system do not wire to the reverse cable.

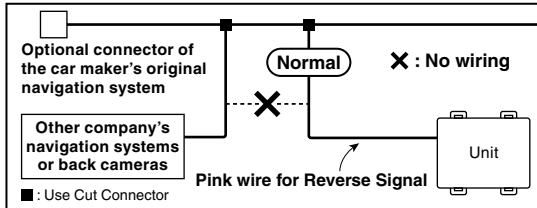

(Check Wiring) If in SPORTS Mode, when the reverse signal is input the display will read **bA C** and the unit will switch to NORMAL Mode.

bA C

• In some car models, voltage detector which is supplied with product doesn't work because of the current capacity shortage. Please use analog multimeter and others in this case.

[Reference 1] How to use the Voltage Detector (supplied with product)

<p>1 Loosen an earthed screw, insert and fasten the wire tip (coiled wire).</p> <p>Metal part Wire tip</p>	<p>Note: As an earthing screw, only use a screw that is fastened to a metal part. Painted screws and screws connected to plastic parts become insulated and cannot carry electricity.</p> <p>Plastic part (crossed out) Painted screw (crossed out)</p>
<p>2 Connect the tip of the LED to the place you wish to test voltage.</p> <p>Earth (Screw, etc...) Voltage Detector (supplied with product) LED lamp</p>	<p>Lamp on : 12V Lamp off : 0V</p> <p>LED lamp</p>

[Reference 2] How to use the Cut Connectors

<p>1 10 mm Peel off of the vinyl cover at connection.</p>	<p>2 10 mm Peel off of the vinyl cover at the end of the product's wire.</p>	<p>3 Wrap around both wire coils.</p>	<p>4 Close tightly with cut connector.</p>	<p>5 Insulate with vinyl tape.</p>	<p>When crimping, please use crimpers or use pliers to bend and then solder together.</p>
--	---	--	---	-------------------------------------	---

After inserting the connector, pull lightly to make sure that it is securely locked.

Power Cable

8-pin Connector

Connect to the side of the unit.

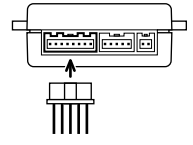

Controller

5-pin Connector

Connect to the side of the unit.

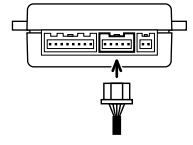

Special Model Specific Harness (sold separately)

6-pin Connector

Connect to the side of the unit.

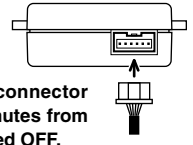

Only disconnect the accelerator connector after having waited at least 15 minutes from the time that the ignition was turned OFF.

Depending on the type of vehicle, if the connector is disconnected before the ECU power is switched OFF, the Check Engine Light may go on. (If the Light comes on: Refer to Page 12, "How to Turn Off the Check Engine Light")

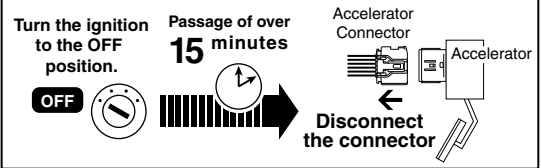

Note: For details about connecting the specialized harness, please refer to the user's manual that came with that harness.

Remote Switch (sold separately)

2-pin Connector

Connect to the side of the unit.

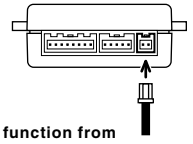

You can set and deactivate AUTO CRUISE function from Remote Switch instead of the controller. It's possible to attach on the wiper lever.

Product number : LSW ¥2,286



Wiring for when you wish not use AUTO CRUISE

Red

Normally 12V (OK for other than brake)

Black

Earth

Gray

Orange Do not connect to anywhere

Before Using

Features

Connecting The Wires

Installing The Product

Initial Settings

Speed Pulse Settings

How to Operate

Trouble-Shooting

procedure 2

Installing The Product



Do not use magnetic holders, such as for a smartphone, to prevent malfunction.



Please be sure to bundle away all wires with tape not to get damaged by any steel plate or screws as this may cause short circuit.

Installing The Controller

Install the Controller to a position which is easy to see.

(Example of Installation)

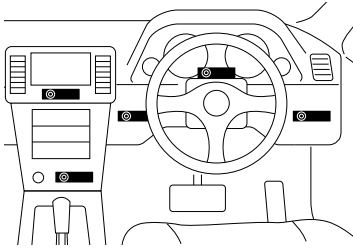

Fastening to a Flat Place

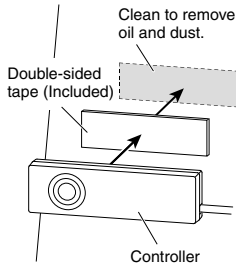

Using the L-shaped Fastener

By using the L-shaped Fastener that comes with this product, it is possible to install the unit on the dashboard even if it is curved or on an angle.

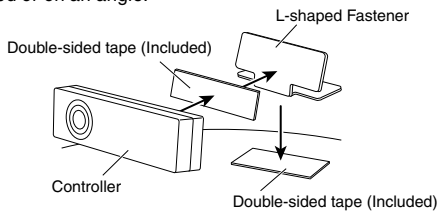

Note: It is possible to install the L-shaped Fastener in the reverse direction.

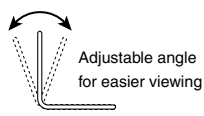
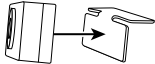

Cable processing of the Unit

Fasten the cables not to disconnect connectors by getting caught on cables.

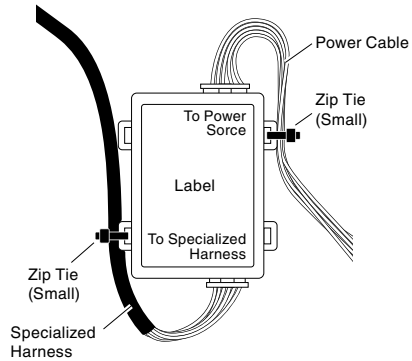

Installing The Unit

As shown in the diagram below, fasten the unit into positions not usually affected by water.

(Example of Installation)

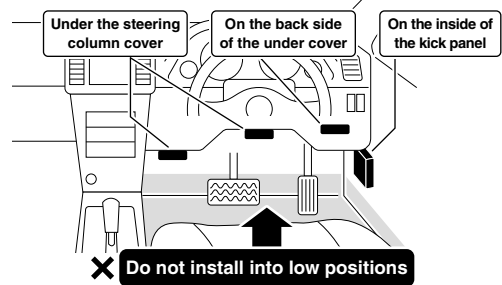

Fastening to a Flat Place

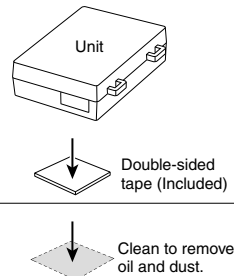

procedure 3

Initial Settings (Degree of Acceleration Setting)

Make sure to carry out these settings.

When installing for the first time



When installing into a different car



- This operation sets the car's accelerator characteristics into the controller unit.
- If the "Initial Settings" are not carried out, the unit will remain in NORMAL Mode even if the Mode is switched.
- If this settings have been improperly made a Check Engine Light may go on.

Before making the "Initial Settings"

1. Make settings only after having completed all wiring (connector installation).
2. Make settings with the **ignition in the ON position (engine not running)** and the gear in **P** (Parking) or **N** (Neutral).

[Making the Settings]

■ : Controller Display Area, () contains additional explanation

1 Turn the ignition ON.
(Engine not running)

• nor will appear. **nor** (NORMAL Mode)

Without braking, press down twice

⚠ If nor does not appear, press the MODE switch until nor appears.

2 Press the UP switch for 10 seconds or longer to change the display to 0.

Press until "0" appears

car ⇒ **-5-** **-4-** ... **-0-**

(Count down from 5 to 0 after the car blink.)

3 When 0 appears release the UP switch.

Release

-0-

4 Accelerator pedal is not pressed down.
(Release the accelerator to 0%)
(e.g.) **L15**

0%

(Voltage Display: e.g., 1.5V. The values shown in the display will vary depending on the type of car.)

5 With the accelerator at 0%, press the SET switch.

Press

• SEt will appear. **SEt**

Set to 0%

6 Pedal is completely pressed down.
(Press in on the accelerator to 100%)
(e.g.) **H45**

100%

(Voltage Display: e.g., 4.5V. The values shown in the display will vary depending on the type of car.)

7 With the accelerator at 100%, press the SET switch.

Press

• SEt will appear. **SEt**

Set to 100%

⚠ If Err is displayed

If after the Err is shown the display returns to as shown in 4 (L15 or so on), it means that the degree of acceleration settings have not been confirmed properly. Re-do the settings from step 4.

8 Press down on the accelerator pedal until 100 appears.

SEt ⇒ **nor** ⇒ **100**

9 Once the display changes to 100 release the accelerator.

100 ⇒ **nor**

10 Setting Completed

If the device is re-installed into a different vehicle, make sure to carry out these settings again.

After having finished settings and the battery or wires have been disconnected it is not necessary to carry out "Initial Settings".

Check the Settings (If the display is incorrect start again from step 2 above.)

<p>Do not press in on pedal</p> <p>0% ⇒ nor</p>	<p>Press down on pedal</p> <p>100% (See Note below) ⇒ 100</p>
--	--

Note: Depending on characteristics of the accelerator or on how the accelerator is stepped on the display may read R95 (95%).

Before Using

Features

Connecting The Wires

Installing The Product

Initial Settings this operation. Make sure to carry out

Speed Pulse Settings

How to Operate







Trouble-Shooting





procedure 4

Speed Pulse Settings

For details about Pulse settings, see the "Wiring Chart".

Before Using
Features
Connecting The Wires
Installing The Product
Initial Settings
Speed Pulse Settings
How to Operate
Trouble-Shooting







- 1 Turn the ignition to ON.**
 (Engine not running)
 • **nor** will appear.  (NORMAL Mode)
 Without braking, press down twice  or 
 ⚠ If **nor** does not appear, press the MODE switch until **nor** appears.
- 2 Press the DOWN switch for 3 seconds.**
 • **PLS** will appear.   Press the switch for 3 seconds
- 3 Release the DOWN switch.**
 • The pulse number will appear.   Release

- 4 Press the UP / DOWN switches to select the desired pulse setting.**  Press
 (Factory Setting)
 - 5 If no operation is carried out for 3 seconds, the display will begin blinking.**

 - 6 If no operation is carried out for 5 seconds, the display will change from blinking to NORMAL Mode.**
 **Setting Completed**
- ⚠ Make sure to set the car's speed pulse settings correctly. If the pulse settings are incorrect, the AUTO CRUISE setting may be impossible even within the usual setting range of 30 to 140 km/h.

Test Drive

After having carried out all of the necessary wiring and making settings in "Initial Settings" and "Speed Pulse Settings" please carry out a low-speed test run.

⚠ Please carry out the test drive in a safe spacious area away from pedestrians and traffic. Please make sure to carefully read this manual and understand how to operate the unit before taking a test run.

- 1 Engine Start.** 
 - 2 Start the Test Run.**
 (35-40 km/h) 
 - 3 Press the SET switch.** 
 - 4 AUTO CRUISE kicks in at the set speed.** 
 - If **Acc** appears, There is no problems with wiring or settings.
 - ✗ If **Acc** does not appear, Check the items to the right.
- Deactivating AUTO CRUISE • Press the brake pedal. • Press the OFF / RES switch.
- If **-b-** appears, Poor connection of Gray wire. See page 4-5. Improper wiring of Pink wire. See page 5. 
 - If **- - -** appears, The pulse setting is incorrect. See page 8. Improper wiring of Orange wire. See page 5. 
 - If the display does not change despite pressing the switch, The "Initial Settings" are incorrect See page 7.

Basic Operation

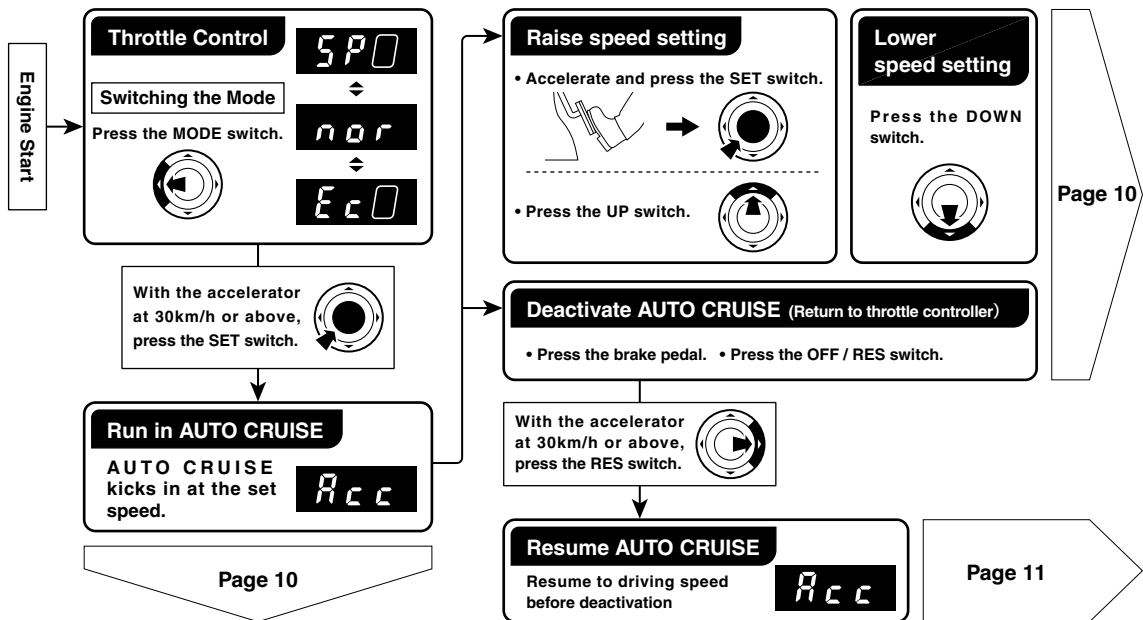

Operating the Throttle Controller

Before Using

Features

Connecting The Wires

Installing The Product

Initial Settings

Speed Pulse Settings

How to Operate

Trouble-Shooting

Switching Response Levels

Make settings for response in each Mode.

Switching the Mode

1 Engine Start.  START

2 The Mode will change with each pressing of the MODE switch.  Press

SPORTS Mode  Higher Response

NORMAL Mode  Normal Conditions

ECO Mode  Lower Response

Note: For safety, when changing modes always go through *n o r* (NORMAL) one time.

About the Relay sound

When switching to *n o r* for safety reasons the relay will go into operation and you will hear a clicking sound.

Adjusting the Change Ratio for each Mode

! When making adjustments to the change ratios, begin at the lowest setting and slowly make changes while continually checking acceleration.

• Switching the Change Ratio for SPORTS Mode

SP0 is displayed, the ratio will change with each pressing of the UP / DOWN switch.



Greatest Change Ratio (SP ↑ side)

Lowest Change Ratio (SP ↓ side)

Smallest Change Ratio **SP1** (+10%) **SP2** (+20%) **SP3** (+30%) ... **SP6** (+60%) **SP7** (+70%)

• Switching the Change Ratio for ECO Mode

EC0 is displayed, the ratio will change with each pressing of the UP / DOWN switch.



Lowest Change Ratio (EC ↓ side)

Greatest Change Ratio (EC ↑ side)

Greatest Change Ratio **EC5** (-50%) **EC4** (-40%) **EC3** (-30%) **EC2** (-20%) **EC1** (-10%)

! Saving Settings

All settings are saved even after the ignition has been turned OFF. However, if the ignition is turned OFF in 2 seconds or less after the last setting operation was carried out, the settings will not be saved.

[Reference 1] Examples of changes in fuel consumption and response depending on change ratios

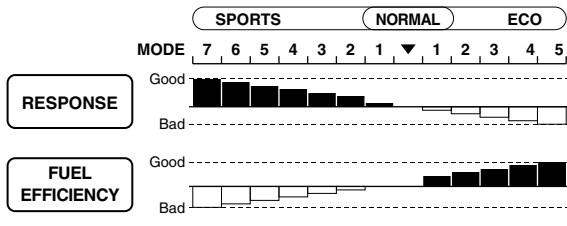

Note: In ECO Mode, because response is less than the standard fuel efficiency can be improved. However, if rapid acceleration is purposefully carried out fuel efficiency will be reduced. The changes in response will be greater as the vehicle's power is greater.

[Reference 2] Basic Control Features

The changes throughout each Mode will be controlled smoothly without perceptible steps.

Acceleration output signal based on amount of pressure placed on accelerator pedal

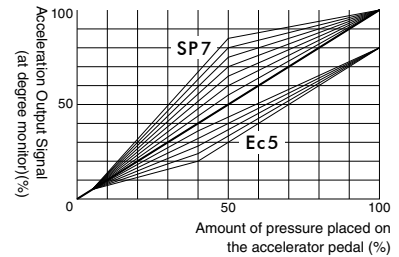

Degree of Acceleration Monitor

Displays the amount of pressure placed on the accelerator pedal. (output signal) [15–100%, 5% unit]

Degree of Acceleration Monitor shows the rate of acceleration output to the ECU where 0 represents the pedal not being pressed in and 100 equals when the pedal is fully pressed down.

Note: When in ECO Mode, even if the accelerator is stepped on a full 100% the output signal will only be 80%.

Depending on characteristics of the accelerator or on how the accelerator is stepped on the display may read up to 95%. (When in SPORTS Mode and NORMAL Mode only)

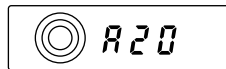

Degree of Acceleration (output) 20%

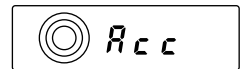

While in AUTO CRUISE (no degree display)

USE 1 Check acceleration during ECO driving

To ensure reduced fuel consumption during acceleration the degree of acceleration should be between 15% and 25%. To further improve results use ECO Mode when wishing to save fuel.



USE 2 Check acceleration during regular driving

Please use to check the degree of acceleration for any type of driving, not just ECO Mode.

USE 3 Check control status

With the ignition in the ON position and under NORMAL Mode press in the pedal until it reaches 40% (R40), if the Mode is changed to SP↑ the display should read 65% (R65) and if placed in EC↓ the display should change to 20% (R20).

[See the above Graph of "Basic Control Features"] Note: The actual display may differ slightly.

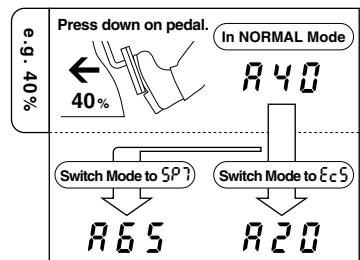

Operating the AUTO CRUISE

After setting to AUTO CRUISE, you can drive automatically at the set speed even without pressing down on the accelerator pedal.

- AUTO CRUISE is nothing more than an aid to assist drivers. Please make sure to follow all speed limits and practice safe driving.
- AUTO CRUISE can be dangerous if activated in the following conditions; do not use under these conditions.
 1. On slippery Roads (snow and ice)
 2. In traffic jams
 3. Around sudden curves and/or slopes
- Upon climbing a sudden slope, it is not possible to accelerate beyond the capability of the engine. Moreover, when going down a sudden decline the engine can not force deceleration other than from the engine brake; please use the brake when necessary.
- To avoid an increase in engine revolutions, do not put the gear in N (neutral) or any other gear other than D (drive) while in AUTO CRUISE.

[Settable Speed]

Approximately 30–140 km/h

Due to differences in some standard meters, the setting will fall in the range of **between 35 and 145 km/h**.

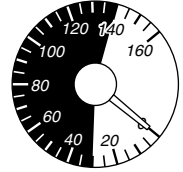

Set

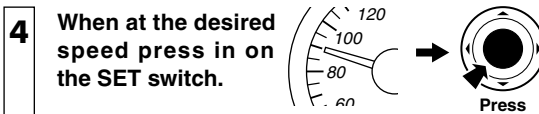
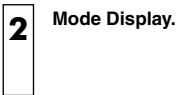
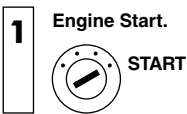

Note 1: Please try to set when there is as little change in speed as possible.
Note 2: When setting during a sudden hill climb the car will run more stably after decelerating a little.

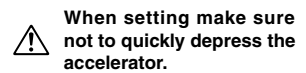

About the Relay sound (clicking noise)

If you set under NORMAL Mode (n o r) you will hear a noise from the relay working. If this bothers you, please set while in S P I or E c t.

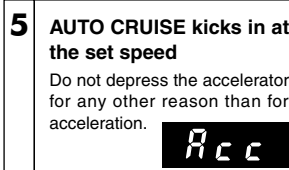

[How to temporarily accelerate]

1. Press down on accelerator pedal to accelerate.
2. By taking foot off the pedal will return to AUTO CRUISE speed as in [5].

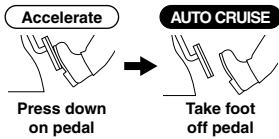

Deactivate

AUTO CRUISE can be deactivated using any of the following:

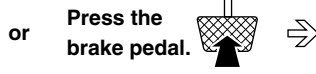

This deactivates AUTO CRUISE and returns to the throttle controller

[Auto-Deactivation]

- When the speed declines to 15 km/h or less.

Change the Speed Setting

It is possible to use of the following methods to change the speed setting while driving in AUTO CRUISE.

Raise Speed Setting by Accelerating

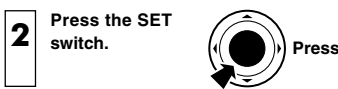
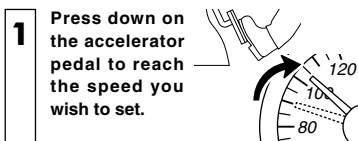
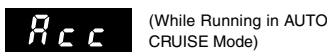

Change Speed Setting by Pressing UP / DOWN Switch

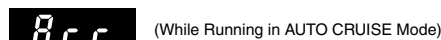

- Press the UP switch. H ↑ appears and the setting can be raised.
- Press the DOWN switch. H ↓ appears and the setting can be lowered.

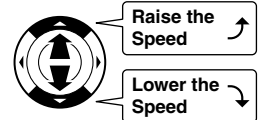

Each press is 2 km/h
Press twice and the change is 4 km/h,
press 3 times and the change is 6 km/h...

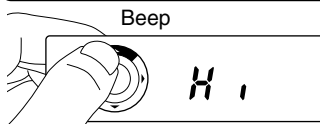

Press down until you reach the desired speed



Upon each press you will hear a "beep", and the speed will be raised or lowered by 2 km/h. The speed will be raised or lowered according to the number of times the switch is pressed and will automatically drive at that speed.

After one beep, the sound will change to consecutive beeps. Speed will be raised or lowered while the switch is being pressed down and will automatically run at the speed when the switch is released.

Note: If the alarm sound has been turned OFF, the beep will not sound.
This cannot reduce speed more than using the engine brake; when going down steep slopes speed may be unable to be lowered.

Resume

After deactivating AUTO CRUISE, by simply pressing the switch you can return to driving at the set speed.

- 1** Deactivate AUTO CRUISE
- 2** Normal Driving (30km/h or above)
- 3** Press the RES switch.
- 4** rES appears for 5 seconds and then changes to Acc.
- 5** The car will automatically accelerate (or decelerate) to the previously set speed and run on AUTO CRUISE.

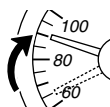

Note: For safety purposes, if after deactivation of AUTO CRUISE, the car runs at 10km/h or less (meter shows 15 km/h or less) the speed setting will be reset to 0 and AUTO CRUISE will not resume.

Adjust Level

Depending on the size of your car's engine the amount of time it takes to return to the set cruising speed after a hill climb or other such condition will differ. By adjusting the level it is possible to change the amount of time for returning to the set cruising speed to be faster or slower to match your car's performance and desired ride. Level adjustments may differ depending on car model or driving conditions; please use the following as a simple guideline and adjust to fit your needs. (The factory default setting is L-3)

Up to L-5 (Quick Acceleration) For Smaller Engines	In car models with smaller engines, to have the car return to the set speed faster raise the level to L-5.	Quicker Return	L-5 ↑ L-4 ↑ L-3 (Factory Setting) ↓ L-2 ↓ L-1	For Smaller Engines Quick (Lessen difference in returning to speed) Amount of Time to Return to Set Cruise Speed Slow (For more comfortable return to speed) For Larger Engines	[Setting Examples]
Down to L-1 (Slow Acceleration) For Larger Engines	In larger engine car models, to have the car ride more comfortably without sudden acceleration to return to the set speed, lower the level to L-1.	Slower Return			L-5 ALTO L-4 MARCH, FIT, DEMIO, WAGON R L-3 VOXY, PRIUS, CARAVAN, SERENA, INSIGHT, STEP WGN, SWIFT L-2 VELLFIRE, CROWN, HIACE, ELGRAND, LAGACY, MPV, RX-8

⚠ Operating switches or checking the display while driving may cause accidents; please use with the utmost consideration for safety.

[Making the Settings]

- 1** Press the MODE switch.
 - 2** Current Level Appears
 - 3** The Mode will change with each pressing of the MODE switch.
- While Running in AUTO CRUISE Mode
- Low Level → L-1 → L-2 → L-3 → L-4 → L-5 → High Level
(Factory Setting)

Troubleshooting

Concerning Basic Operations and Car Problems

Trouble	Possible Causes	Possible Solutions
The ignition is set to the ON position but the display of the Main Unit will not light up. OR the display goes OFF while in use.	Brake fuse is burned out. The (Red) and (Black) wire may have been improperly wired or there is a poor connection. Poor connection of (5-pin Connector), (8-pin Connector) and (6-pin Connector). Poor connection of (Specialized Harness). (Specialized Harness) being used is incorrect.	Please reconfirm whether wiring and connections are correct or not.
With the ignition switched to ON, only the dot appears.	The (Black) wire may have been improperly wired or there is a poor connection.	Please reconfirm whether wiring and connections are correct or not.
A Check Engine Light has gone on.	The accelerator connector or (Specialized Harness) was disconnected with the ignition in the ON position or within 15 minutes after having turned the ignition OFF. The "Initial Settings" have not been properly carried out. The product was in a mode other than NORMAL Mode when removed from a car and installed into a different car.	Re-connect the disconnected connector and turn off the Light (See page 12 of this manual). Make the "Initial Settings" (See page 7 of this manual) and turn off the Light (See page 12). After returning it to NORMAL Mode, carry out the "Initial Settings" (See page 7 of this manual) and turn off the Light (See page 12).
It will not go into "Initial Settings" or "Speed Pulse Settings".	The (Orange) wire may have been improperly wired or there is a poor connection. The car is being driven.	Please reconfirm whether wiring and connections are correct or not. Carry out after stopping the car.
While making "Initial Settings" an Err appears in the display.	The "Initial Settings" have not been properly carried out.	Make the "Initial Settings" (See page 7 of this manual).

Before Using

Features

Connecting The Wires

Installing The Product

Initial Settings

Speed Pulse Settings

How to Operate

Trouble-Shooting

Concerning the Throttle Controller

Trouble	Possible Causes	Possible Solutions
Even if the Mode is changed, the changes cannot be felt.	The "Initial Settings" have not been properly carried out.	Make the "Initial Settings" (See page 7 of this manual).
The Mode and/or the setting of change ratios can not be saved.	The ignition has been turned to the OFF position immediately after having finished the setting of change ratios or changing the Mode.	After having made settings of change ratios or changing the Mode, wait for at least two seconds before turning the ignition to the OFF position.
While in SPORTS Mode, when put into reverse the display does not show bRc .	The (Pink) wire may have been improperly wired or there is a poor connection.	Please reconfirm whether wiring and connections are correct or not.
	The unit is connected to the reverse wire of a navigation system from another company.	Carry out Wiring to Reverse (See page 5 of this manual).
	The backup lights have been changed to LED lamps.	<ul style="list-style-type: none"> • Replace the backup lights with the car maker's original lights. • Do not carry out wiring for Reverse Gear.

Concerning AUTO CRUISE

Trouble	Possible Causes	Possible Solutions		
-b- appears in display and AUTO CRUISE will not operate.	The (Gray) and (Pink) wires may have been improperly wired or there is a poor connection. The brake lamp bulbs have been changed to LED lamp bulbs.	Please reconfirm whether wiring and connections are correct or not.		
--- appears in display and AUTO CRUISE will not operate.	The (Orange) wire may have been improperly wired or there is a poor connection.	Please reconfirm whether wiring and connections are correct or not and that the speed is within the setting range.		
	The setting is outside the allowable range.			
	"Speed Pulse Settings" have not been properly carried out.	Make the "Speed Pulse Settings" (See page 8 of this manual).		
The display does not change even when the SET switch is pressed and AUTO CRUISE will not operate.	The "Initial Settings" have not been properly carried out.	Make the "Initial Settings" (See page 7 of this manual).		
AUTO CRUISE is automatically deactivated and the display switches to throttle controller.	No sound	The (Gray) wire may have been improperly wired or there is a poor connection.	Please reconfirm whether wiring and connections are correct or not. Note: To use AUTO CRUISE again, first turn the ignition to the OFF position and after you have made sure that the display has gone off, start the engine again.	
	Hear "beep" sound	The (Orange) and (Pink) wires may have been improperly wired or there is a poor connection.		
		The "Initial Settings" have not been properly carried out.		Make the "Initial Settings" (See page 7 of this manual).
		It will be automatically deactivated when speed drops to 15 km/h or less.		
When climbing a hill, the speed is much slower than the set cruise speed.	The AUTO CRUISE Level has been adjusted to a lower level (lowest is L-1).	Carry out "Adjusting AUTO CRUISE Level" (See page 11 of this manual).		
It feels like to return to the AUTO CRUISE speed is too quick and jumpy.	The AUTO CRUISE Level has been adjusted to a higher level (highest is L-5).			

Note

How to Turn Off the Check Engine Light

If the Check Engine Light comes on due to some operational mistake, please follow the directions below to turn it off.

1. Under normal conditions, start and stop the engine several times.
2. If that does not turn off the lamp, disconnect the cable from minus terminal of the battery for about 10 minutes.
3. If that does not turn off the lamp, please consult your local car dealer and have them turn it off.

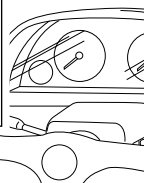

Note

How to turn OFF the Alarm Sound

If you wish to turn off the alarm sound while making AUTO CRUISE settings, press the MODE switch for a long time.

(When engine has been started) Long press on MODE switch



Note: This setting cannot be changed while running in AUTO CRUISE. If you wish to return to having the alarm sound, carry out the same procedure again. Even if the alarm sound has been turned to OFF, it will come back ON when carrying out "Initial Settings" or "Speed Pulse Settings".

- (Note)**
- Our products have already been recognized as our Industrial Property or are in the process of receiving Industrial Property status.
 - We plan in the near future to take all possible legal measures to protect against unfair competition from look-alike products using similar designs, regulating characteristics, circuitry and circuitry layout.
 - We strictly prohibit the unlicensed use of the PIVOT trademark and the unauthorized use of PIVOT User's Manual.