

USER'S MANUAL

Triple Gauge Set for BMW 52X-BM

Thank you for purchasing this PIVOT product.
Please read this manual carefully and keep it for future reference.

- If this product is given to another user, make sure to include this User's Manual.

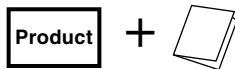

Please check the contents of the package

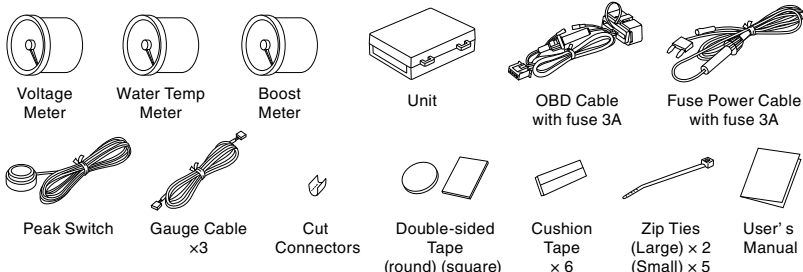

● You need the 3DDesign corporation brand Gauge Panel to install.(included in the full kit)

Contents

Contents / WARNING / CAUTION 1
 Features 1
 Part Names and Displays 1
 Connecting The Wires and Installing The Product 2~3
 Basic Operation 4
 Switching The Display 4
 Troubleshooting 4

1. The display will not be proper if the ECU being used is not the standard one or if a sub-computer is being used, even in compatible car models.
2. Cannot be used in combination with other company's products that use Diagnostic Monitoring Connectors.
3. For details about using in combination with other PIVOT products that use Diagnostic Monitoring Connectors please see our Web Site at <http://pivotjp.com/obd-e/>.
4. On account of the mounting location, original cigar lighter and ashtray you will not be able to use.

WARNING

Improper use or disregard of these warnings may result in the injury or death of people.

- **Do not work in areas where there is excessive exhaust.**
Due to vehicle exhaust emission poisoning or fire may result in a damage to humans.
- **Do not operate while driving.**
Operating or checking the display during driving may cause an accident; please use with the utmost consideration for safety.
- **Do not crush the cable.**
Please be careful that the cable does not get crushed by the seat rail or car door steel plate, nor cut by any sharp steel plate as this may cause a poor connection or an electric short leading to fire or other danger.
- **Please securely fasten the product to a stable place and be sure to store bundle away all wires with tape, etc...**
It is very dangerous to pull tangled wires by force or allow tangled wires to interfere with driving.

CAUTION

Improper use or disregard of these warnings may cause injury to persons, damage the product and other things.

- **This product is for DC12V cars;**
Installation cannot be carried out on cars with other voltage batteries.
- **Just after installation do not exert any strong force on the product.**
When double-sided tape is used for an installation be warned that when hot the tape temporarily loses adhesiveness.
- **Do Not Use Chemical Cleansers.**
If the unit gets dirty please wipe with a soft cloth to remove any dirt. Do not use chemical cleansers such as thinner, benzene, or alcohol.
- **Do not install the product in any place subject to high temperature or any place where water may be splashed.**
- **Make sure to replace all screws and parts to their original place.**
- **Do not install the product in a place where it will cause distraction.**
- **Do not, in any manner, process, take apart, or make changes to this product.**

Features

- Triple Gauge
- Peak Switch
- LED Illumination
- No Piping or Wiring Necessary
- Stepping Motor Drive

Simultaneous display of three types of data: Boost, Water Temperature and Voltage.
 Boost and Water temp gauge can display the maximum value and Voltage gauge can display the lowest value.
 Standard Matching Orange Illumination.(keep lighting the meter in operation)
 It is possible to connect directly to the diagnostic monitoring connector meaning there is no need for troublesome wiring.
 Our stepping motor is able to provide a smooth, highly precise display.

Displays and Uses

Voltage

Display 7V~17V
 Use Check battery

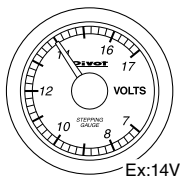

Water Temp

20°C~120°C
 Prevention of overheating
 Check Heating etc.

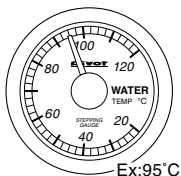

Boost

0~154kPa
 Check Boost etc.
 (Absolute pressure display)

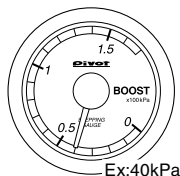

Opening Demo

The needle will move to the lowest value side several times, then it will move to the maximum value and finally to reading for current measurement item.

Part Names [Meter]

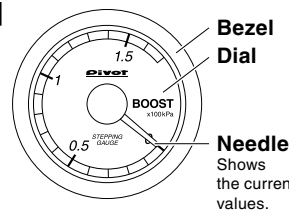

Size [Unit : mm]

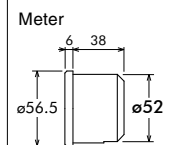

[Unit]

(View from Gauge Connection)

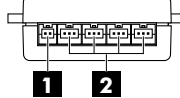

(View from Car Connection)

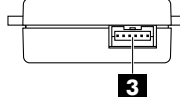

- 1 Peak Switch connector
Connect Peak Switch
- 2 Meter connector
Connect gauge cable
- 3 Power connector
Connect OBD Cable

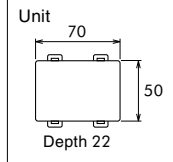

Connecting the Wires and Installing the Product

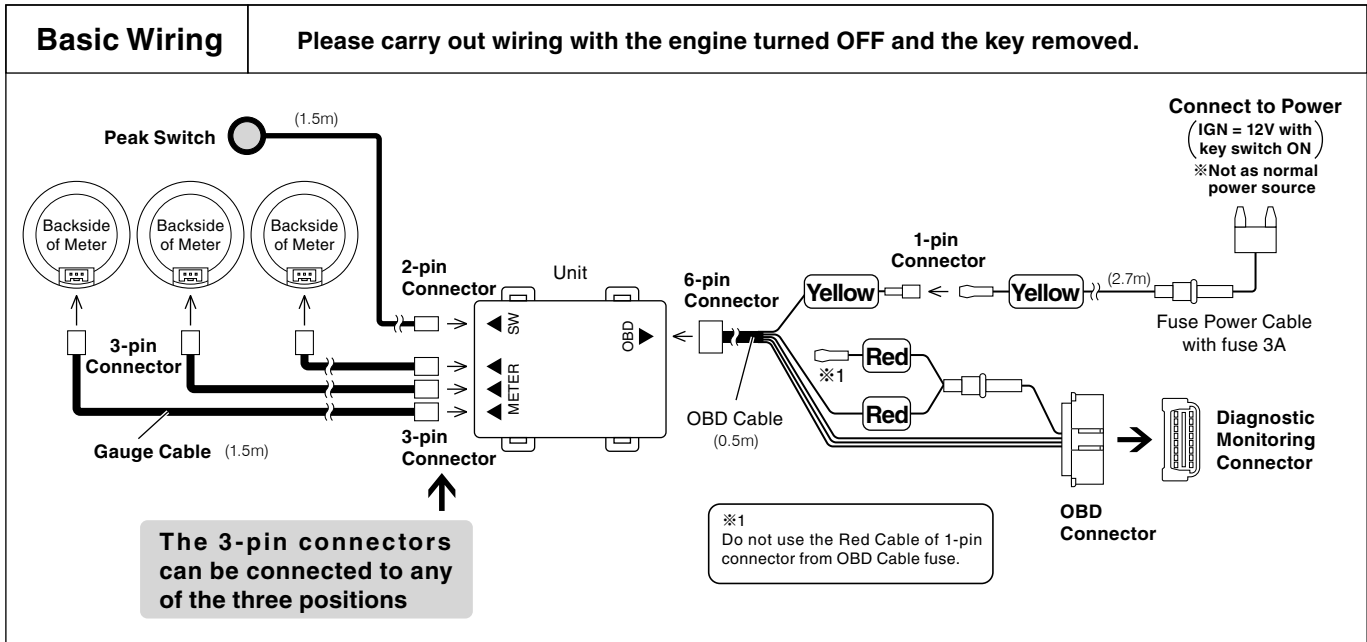

1 Connecting to Power (In case of right-hand drive)

In case of 1 and 3 series

- ① Remove the under cover of the passenger side glove box.
- ② Open the bonnet and check the position of the fuse box.

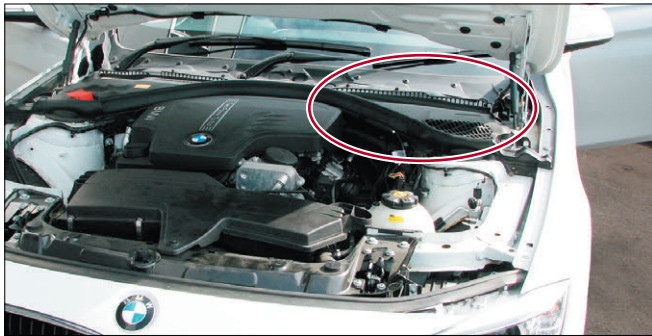

- ③ Remove the cover above the fuse box.

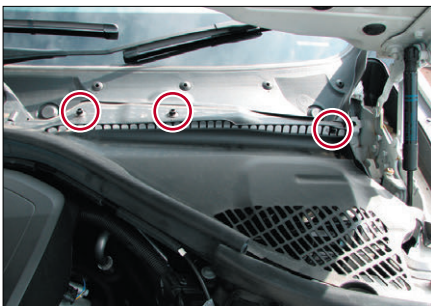

- ④ Remove the fuse box cover.



- ⑤ Pry open the fuse case using such as drivers.

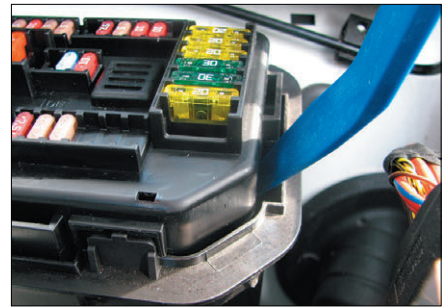

- ⑥ Pass the Fuse Power Cable through the hole in the fuse case back and pull it to car interior and connect the 1-pin Connector.

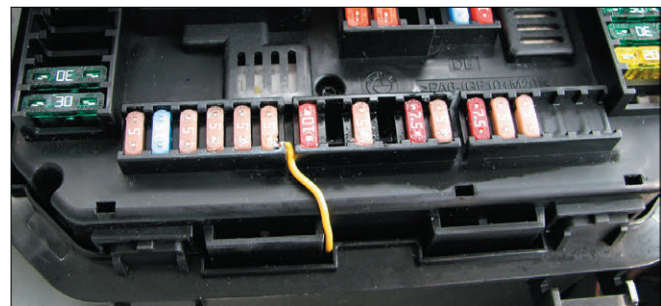
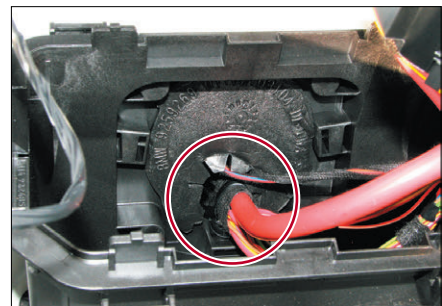

- ⑦ Replace the original fuse 5A of the sixth position from the left to the fuse of the Fuse Power Cable.

- ⑧ Routed the Fuse Power Cable as shown in the figure.
- ⑨ Return in the reverse order.

In case of Z4

- Remove the under cover of the passenger side glove box. (3 places screw)



- Cut the fuse of Fuse Power Cable as shown in the diagram.

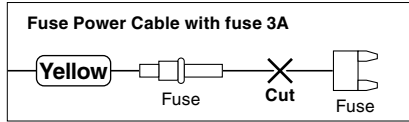

- Connect the cable of 2-pin connector (the position of the figure) on back of the cigar lighter socket to the tip of the Fuse Power Cable using Cut Connector.

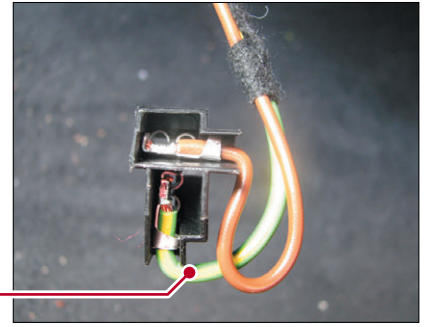

- Put back the under cover.

[Reference 1] How to use the Cut Connectors

<ol style="list-style-type: none"> <p>Peel off of the vinyl cover at connection.</p> 	<ol style="list-style-type: none"> <p>Peel off of the vinyl cover at the end of the product's wire.</p> 	<ol style="list-style-type: none"> <p>Wrap around both wire coils.</p> 	<ol style="list-style-type: none"> <p>Close tightly with cut connector.</p> 	<ol style="list-style-type: none"> <p>Insulate with vinyl tape.</p> 	<p>When crimping, please use crimpers or use pliers to bend and then solder together.</p>
---	--	---	--	--	---

2 Connecting each Cable and the Unit

- Laying the Gauge Cable from the mounting position of the Meter to the Unit.
- Connect 1-pin connector of the Fuse Power Cable to the 1-pin connector of OBD Cable.
- Connect the Peak Switch, the Gauge Cable and the OBD Cable to the Unit.
- Insert the OBD Connector to the diagnostic monitoring connector. (Remove the cover of the diagnostic monitoring connector if it's annoying.)

[Reference 2] Notes about using the OBD Connector

<p>Make sure to grip the distended portions when pulling it out or inserting it.</p>	<p>CAUTION</p> <p>Do not pull on the wires when trying to remove the connector; the wires may become disconnected.</p>
<p>If you unable to get a grip on the distended portions.</p> <p>With some car models it may be difficult to get a good grip on the connector.</p>	<p>In such case, pull out the connector by pulling on the end of the zip tie.</p>

3 Installing The Product

Installing the Meter

For procedure of the installation of the meter panel, please refer to the instruction manual of the meter panel (3DDesign Corporation).

- Affix cushion tapes (included) to the Meter.
- Connect the Meter and Gauge Cable, and press into the meter panel.

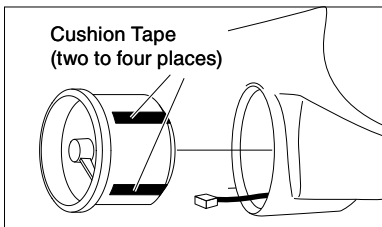

Installing the Unit

Fasten the unit into positions not usually affected by water.

<p>Fastening to Flat Space</p> <p>Double-sided tape (square) (Included)</p> <p>Clean to remove oil and dust.</p>	<p>When Fastenings to a Cable or Pipe</p> <p>Zip tie (Large)</p> <p>Through holes</p> <p>Thick cable or pipe</p>
---	---

Installing the Peak Switch

Fasten the switch to a position that is easy to operate.

<p>Fastening to Flat Space</p> <p>Peak Switch</p> <p>Double-sided tape (round) (Included)</p> <p>Clean to remove oil and dust.</p>

Placement

Basic place would be in the figure, but arrangement on your preference is also possible.

※ Meter can be connected to any of the 3-pin connector.





Installation direction

Can be adjusted to the easy-to-read and preference direction.



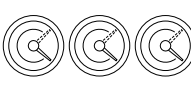
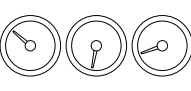

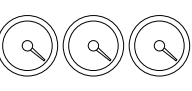
Basic Operation

1 Key Switch ON (Engine start) 	2 Opening Demo (Start-up all together) 	3 Real-time display 	4 Key Switch OFF (Engine stop) 	5 Meter OFF 
--	--	--	---	--

Switching The Display

Peak reading display

- 1**  **Press the switch once**
While the meter is in operation, press the switch once.
- 2**  **Peak reading display**
Display all three meters at the same time.
- 3** **Real-time display**
Back to real-time display after 3 seconds releasing the switch.



Reset the Peak reading

- 1**  **Press the switch for 3 seconds**
Pressing the switch while displaying the peak reading will reset the peak reading.
- 2** **Reset the Peak reading**
Reset all three meters at the same time.
- 3** **Real-time display**

Product	Peak
VOLTAGE	Lowest side
WATER TEMP	Maximum side
BOOST	Maximum side

※Each peak value can be reset by the key OFF.

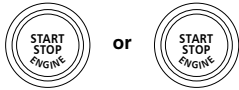
Measuring the lowest voltage by voltmeter

- 1**  **Turn the key switch ON and display the meter**
Without braking, press down twice (1, 3 series) or Without braking, insert the key and press down once (Z4)
- 2**  **Start the engine and check the lowest voltage with Peak reading display**
With braking, press down once

●Recommend to charge or replace the battery if it's lower about 1V or more than when new.

Troubleshooting

Trouble	Possible Causes	Possible Solutions
All three meters do not work.	Poor connection of OBD Connector and Fuse Power Cable .	Please reconfirm whether wiring and connections of OBD Connector and Fuse Power Cable are correct or not.
	Poor connection or wrong wiring of Yellow cable if wired directly to the power supply.	Please reconfirm whether wiring and connections of Yellow cable is correct or not.
	The unit has been installed into an incompatible car model.	Please check the "Fitting List".
One or two meters do not work.	Poor connection of Gauge Cable .	Please reconfirm whether wiring and connections of Gauge Cable is correct or not.
Needle of the boost gauge is shifted to slightly negative from 0 than the others(relative pressure).	Depending on the altitude, needle shifts about one scale by the characteristics of car side sensor (absolute pressure), but this is not a malfunction.	

※Our products have already been recognized as our Industrial Property or are in the process of receiving Industrial Property status.
 ※We plan in the near future to take all possible legal measures to protect against unfair competition from look-alike products using similar designs, regulating characteristics, circuitry and circuitry layout.
 ※We strictly prohibit the unlicensed use of the PIVOT trademark and the unauthorized use of PIVOT User's Manual.