

# USER'S MANUAL

# PROGAUGE

STEPPING DRIVE  
TACHOMETER **052**

Thank you for purchasing this PIVOT product. Please read this manual carefully before installation and use. Please keep this manual for future reference.

If this product is given to another user, make sure to include this User's Manual.

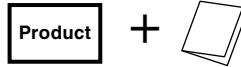

## Contents

Contents/WARNING/CAUTION .....	1
Features .....	1
Part Names and Functions .....	1
Connecting The Wires .....	2
Connection for Cylinder Number Setting .....	3
Fastening The Product .....	4
Basic Operation .....	4
Troubleshooting .....	4

## Please check the contents of the package

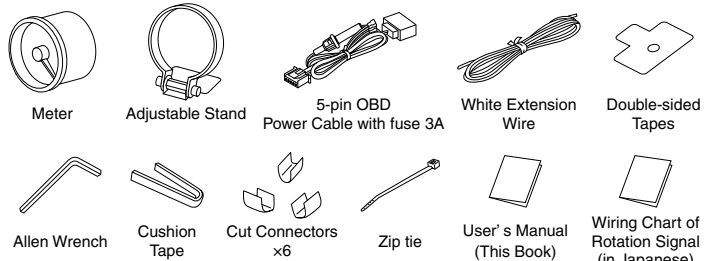

<p><b>WARNING</b></p> <p>Improper use or disregard of these warnings may result in the injury or death of people.</p>	<ul style="list-style-type: none"> <li><b>Do not work in areas where there is excessive exhaust.</b> Due to vehicle exhaust emission poisoning or fire may result in a damage to humans.</li> <li><b>Do not operate while driving.</b> Operating or checking the display during driving may cause an accident; please use with the utmost consideration for safety.</li> </ul>	<ul style="list-style-type: none"> <li><b>During installation be sure to remove the minus cable from the battery.</b> So as to prevent fire and damage resulting from shorting of circuits, etc...</li> <li><b>Do not crush the cable.</b> Please be careful that the cable dose not get crushed by the seat rail or car door steel plate, nor cut by any sharp steel plate as this may cause a poor connection or an electric short leading to fire or other danger.</li> </ul>	<ul style="list-style-type: none"> <li><b>Please securely fasten the product to a stable place and be sure to store bundle away all wires with tape, etc...</b> It is very dangerous to pull tangled wires by force or allow tangled wires to interfere with driving.</li> </ul>
	<p><b>CAUTION</b></p> <p>Improper use or disregard of these warnings may cause injury to persons, damage the product and / or other things.</p>	<ul style="list-style-type: none"> <li><b>Do not use electrotap.</b> Wiring should be carried out using the attached "Cut Connector" or by soldering, make sure to securely insulate all wiring parts with insulation tape, and confirm that no wires are sticking out.</li> <li><b>This product is for DC12V cars.</b> Installation cannot be carried out on cars with other voltage batteries.</li> <li><b>Do not, in any manner, process, take apart, or make changes to this product.</b></li> </ul>	<ul style="list-style-type: none"> <li><b>Just after installation do not exert any strong force on the product.</b> When double-sided tape is used for an installation be warned that when hot the tape temporarily losses adhesiveness.</li> <li><b>Do Not Use Chemical Cleansers.</b> If the unit gets dirty please wipe with a soft cloth to remove any dirt. Do not use chemical cleansers such as thinner, benzene, or alcohol.</li> <li><b>Make sure to replace all screws and parts to their original place.</b></li> </ul>

## Features

The PT5-W is a compact tachometer that can be easily connected to some Toyota, Daihatsu and MINI models by simply connecting the coupler to the Diagnostic Monitoring Connector and for all other model cars can be wired directly for easy installation.

<b>No Wiring</b> Simple Coupler Connection	With some car models it is possible to connect directly using the coupler to the Diagnostic Monitoring Connector.
<b>1-, 3- and 4-cylinder</b> Compatible with wide range	Compatible with 1-, 3- and 4-cylinder cars (4 cycle engine).
<b>All-in-one Body</b> No separate controller necessary.	The meter is of one-body solid construction making it easy to install with only double-sided tape. (No other mounting required)
<b>No need for Opening Holes</b>	Fastening with double-sided tape means no need for opening holes.
<b>Translucent Illumination</b>	The translucent LED system provides a clear even display.

## Part Names and Functions

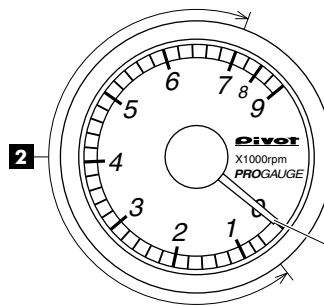

- 1 Needle**  
Show the current values.
- 2 Wide Scale Display**  
The display has been made easier to read by enlarging the 500 to 7000 rpm area.
- 3 Illumination (night illumination)**  
Normally illuminated when on display.

### Opening Demo

During the opening demo, the needle will move slightly to minus several times. Then it will move to the maximum value and finally to reading for current values.

# Connecting The Wires

## Preparation

Before installation, please check the installation method is proper for the model of car.

### Basic Wiring



After carrying out basic wiring, please follow directions under [Connection for Cylinder Number Setting] on Page 3.

#### ■ For Toyota, Daihatsu and MINI

Models which have a ● mark in the “カプラー取付欄 (Coupler Connection)” of the attached “Wiring Chart of Rotation Signal (in Japanese)”.

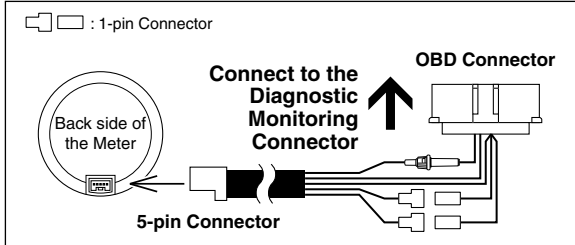

#### Explanation of wires

Color	Wiring place	Details
Red	IGN	12V with key switch ON (or Normal power)
Black	GND	Ground screw, etc.
White	TA	RPM signal
Orange, Green		Connection Cables for Cylinder Number Setting

#### ■ For Popular Models (other than Toyota, Daihatsu and MINI)

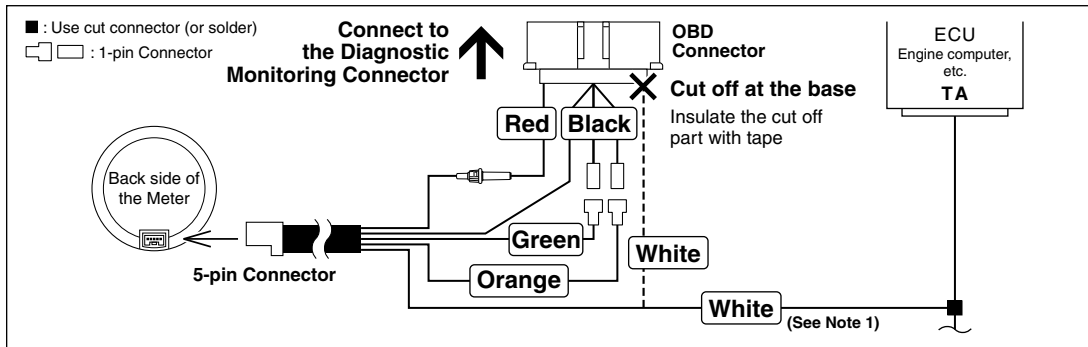

► If there is no Diagnostic Monitoring Connector or if you wish to connect without using it, please follow directions in **Wiring Method 1** ///

When another device is already connected to the RPM signal from the ECU

- and that device works properly keep that wiring.
- and the meter or other device stops working properly or sometimes becomes unstable disconnect from the ECU wire and get the RPM from the minus terminal of ignition coil or diagnosis.

⇒ **Wiring Method 2** ///

#### Note 1:

If the **White** wire is not long enough, please use the white wire provided in this package to extend the length.

⇒ See **[Reference 1] How to use the connectors** on Page 3.

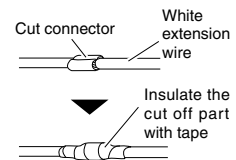

### Wiring Method 1

If you are not using the Diagnostic Monitoring Connector

If you are wiring directly cut off all wires at the base of the OBD Connector.

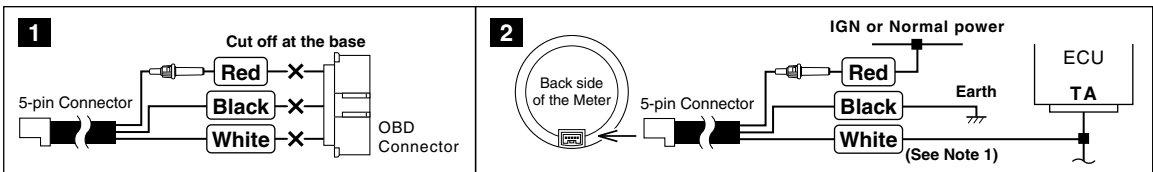

### Wiring Method 2

To get the RPM signal from other than the ECU

#### ■ To get the RPM signal from diagnosis (check connector)

e.g.) in case of MAZDA EUNOS ROADSTER (NA6C)

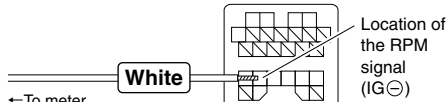
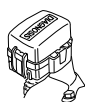

#### ■ To get the RPM signal from the ignition coil

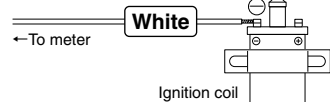

## ! About Using OBD Products in Combination

If you wish to use PT5-W in combination with products in our 3-drive Series or other OBD products, the "OBD2 Wiring Kit OBD-EH" (sold separately ¥3,200) makes installation a snap. For more details about using combinations of products see here. <http://pivotjp.com/obd-e/>

Note: When using the PT5-W with products mentioned above, they can only be used together in compatible model vehicles for both products.

### [Reference 1] How to use the Cut Connectors

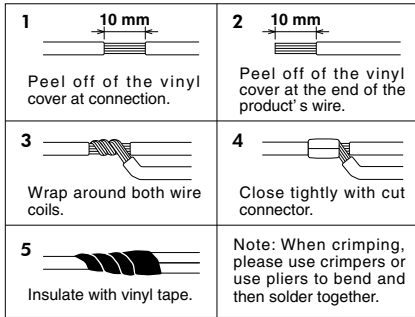

### [Reference 2] Notes about using the OBD Connector

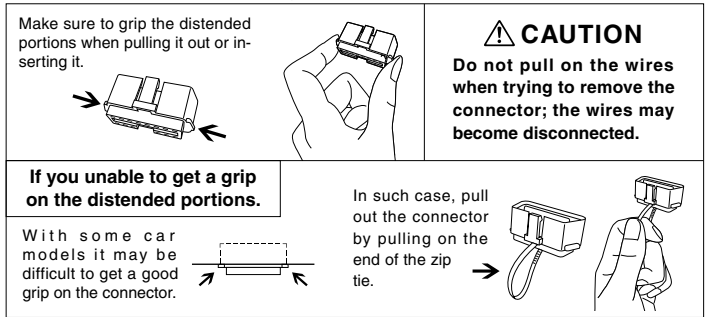

## Connection for Cylinder Number Setting

**Preparation** For details about the number of cylinders and signal level settings, see the attached the "Wiring Chart of Rotation Signal".

Depending on the number of cylinders make connections and insert the OBD Connector to the car's Diagnostic Monitoring Connector as directed below.

To make cylinder number settings, there are a total of four cables which may be used: 2 **Black** (Body Earth) cables from the OBD Connector and 1 **Orange** and 1 **Green** cable from the meter itself.



After having completed cylinder number settings, disconnect the OBD Connector or the 5-pin Connector and reinsert it again. If this is not carried out the settings will not change.

### Four-cylinder

Do not connect the 1-pin Connector.

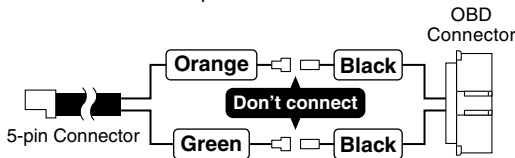

### Three-cylinder

Connect only the 1-pin Connector of the **Green** cable.

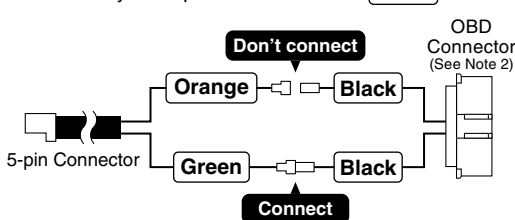

**Note 2: Connection Method without using the OBD Connector**

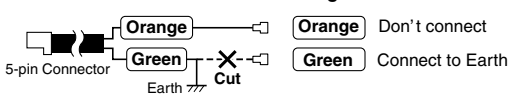

□ □ : 1-pin Connector

### Single cylinder: Signal level 2

Connect only the 1-pin Connector of the **Orange** cable.

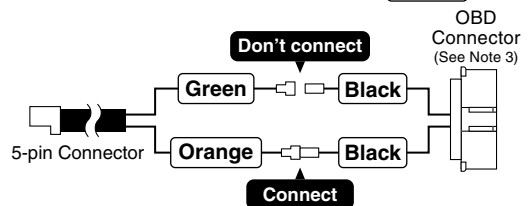

**Note 3: Connection Method without using the OBD Connector**

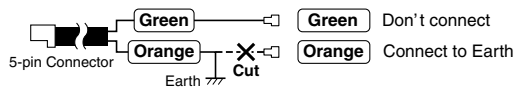

### Single cylinder: Signal level 1

Connect both the 1-pin Connectors of the **Green** and **Orange** cables.

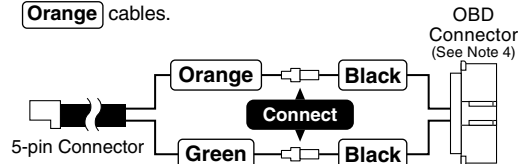

**Note 4: Connection Method without using the OBD Connector**

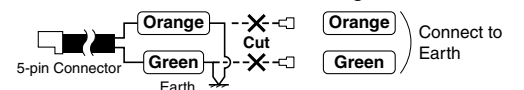

# Fastening The Product

Install in an easy-to-view location.

## A. Installation with the Adjustable Stand

Fasten using the double-sided tape. (On top of the steering column cover or dashboard.)

- 1 Slightly loosen the screw and install the gauge into the Band Holder.
- 2 Fasten using the double-sided tape. (Clean the surface; removing all oil and dust.)
- 3 After deciding the position and angle of the meter face, fasten the hexagonal bolts on both sides to secure.

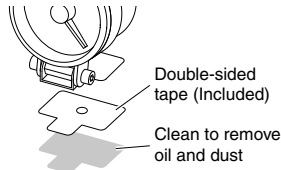
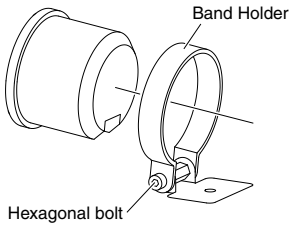

Note: Please be sure about where you wish to install the meter, as it is not advisable to reuse double-sided tape.

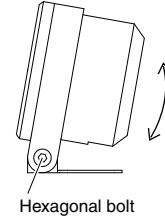

Note: It is possible to install the Adjustable Stand in the reverse direction.

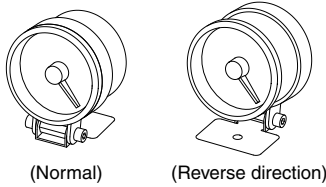

Meter dimensions  
(unit; mm)

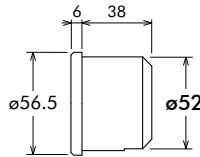

## B. Mount into the Panel

- 1 Wrap the cushion tape around the base of the meter.
- 2 Press into the 52 mm hole in the panel.

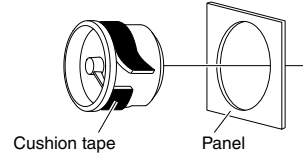

## Basic Operation

Basic operation from engine start to stopping.

- 1 **Key Switch ON**  
(Engine start)
- 2 **Opening Demo**  
It will not operate properly unless the wiring to the RPM signal has been completed.
- 3 **Current RPM display**
- 4 **Key Switch OFF**  
(Engine stop)
- 5 **Meter OFF**  
Note: Due to characteristics of the gauge, even though the engine is off and the gauge is not measuring, the needle will not return to "0".

## Troubleshooting

Trouble	Possible Causes	Possible Solutions
The tachometer does not work. (The Opening Demo does not work.)	The engine does not start.	Start the engine.
	Poor connection of 5-pin Connector cable or OBD Connector.	Check the connections at each connector.
	Poor connection of <b>Red</b> , <b>Black</b> , <b>White</b> wire. (It will not operate properly unless the wiring to the RPM signal has been completed.)	Check the wire connections or conditions.
	The Connection for Cylinder Number Setting is incorrect.	See [Connection for Cylinder Number Setting] on Page 3 and make sure to connect as directed for the number of cylinders.
The car's tachometer and PT5-W reading are very different.	The cylinder setting is wrong.	See [Connection for Cylinder Number Setting] on Page 3 and make sure to connect as directed for the number of cylinders.
The meter is operating even when the engine has been stopped.	Noise from the car (door locks and so on) may cause it to temporarily operate.	If the operation is only temporary it is not a malfunction; but if it still causes worry cut the <b>Red</b> wire in the OBD Connector and connect it to IGN.
With the key off, the needle does not rest on "0".	This is a special characteristic of the meter's movement and is not a malfunction.	
The auto-power window function and/or other electronic devices are re-set.	This is due to the minus terminal on the battery being disconnected.	Re-connect the minus terminal and follow re-setting instructions for any affected devices.