

# USER'S MANUAL (Product Number: THA)

Throttle Controller with AUTO CRUISE Control

## 3 drive · AC AUTO CRUISE & THROTTLE

Thank you for purchasing PIVOT product.  
Please read this manual carefully and keep it for future reference.

If this product is given to another user, make sure to include this User's Manual.

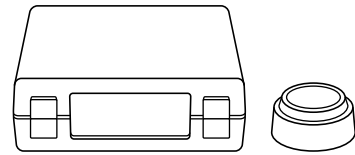
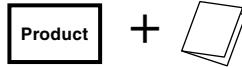

### Contents

Before Using / Contents	1	<b>procedure 4</b> Speed Pulse Settings	8
Product Features	2-3	Basic Operation	8
Features	2	Degree of Acceleration Monitor	9
Part Names / Display Items	3	How to Operate	9-11
WARNING / CAUTION	3	Operating the Throttle Controller	9
<b>procedure 1</b> Connecting The Wires	4-5	Operating the AUTO CRUISE	
Brake Switch	4	Mode Setting / Set and Deactivate	10
Car Speed Signal / Earth / Reverse Signal /		Adjust Level	11
Specialized Harness	5	Test Drive	11
<b>procedure 2</b> Installing The Product	6	Troubleshooting	11-12
<b>procedure 3</b> Initial Settings (Degree of Acceleration Setting)	7		



### After installation, make sure to carry out "Initial Settings".

After having installed this product, make sure to make settings for your car's special characteristics by carrying out the "Initial Settings" on Page 7. If the "Initial Settings" are not carried out, a **Check Engine Light** may go on. Also, the unit will remain in **NORMAL Mode** even if the Mode is switched.

### Worried about Installation?

If you are worried about carrying out wiring or other installation procedures please consult your dealer.

### Only use 3-drive Specialized Harness.

Using another type of harness will cause troubles and failure; use only the 3-drive specialized harness.

### This product can not be installed in car models which come with standard auto-cruise control.

### Set to NORMAL Mode upon Removal of Product.

When uninstalling the product, make sure to return it to **NORMAL** (NORMAL) Mode before carrying out any work. Reconnecting this product in a different mode may cause the **Check Engine Light** to come on.

### Modifying this Product is Forbidden.

Under no circumstances should modifications or changes be made to this product. Doing so may cause damage not only to the product, but to the car and the operation of the car in which it is installed.

### Please check the contents of the package

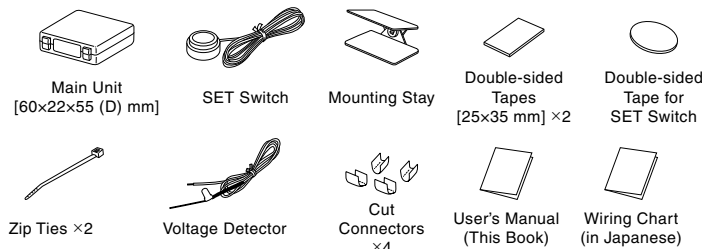

### Tools and Materials to prepare for Installation

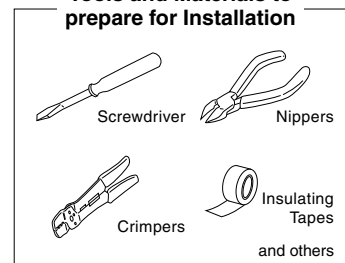

Before Using  
 Features  
 Connecting The Wires  
 Installing The Product  
 Initial Settings  
 Speed Pulse Settings  
 How to Operate  
 Trouble-Shooting

# Features

## Higher Performance Response and AUTO CRUISE Control!

3-drive · AC is our newly designed throttle controller for adjusting response in all types of driving from Sports to Eco-driving; now featuring an AUTO CRUISE function.

### BASIC FEATURES

#### SAFE & SMART

**Compact All-in-One Body** This compact all-in-one body makes it possible to install in out of the way places such as storage box or near the steering wheel.

**Digital Control** Micro-computer control means less noise and less heat.

**Initial Setting Method** Stable balanced control is possible by running the "Initial Settings" program after having finished installation; this will help reduce troubles caused by voltage differences found in each car model.

**Safety First** System designed to give priority to safety even in times of trouble.

### AUTO CRUISE

#### COMFORTABLE & ECO

**AUTO CRUISE** AUTO CRUISE allows you to set the most suitable speed to cruise at while driving; resulting in superior fuel-efficiency. (Approx. 30–140 km/h)

**Stable Speed Control** Our exclusively designed system lessens quick changes in speed; bringing you automatic cruise control with even more comfort.

**User-Friendly Switch for Smooth Operation** The separate switch allows for easy one-handed operation and installs almost anywhere with double-sided tape.

**Deactivating Operation** Stepping on the brake while Auto-Cruise is activated will deactivate its operation and return to normal driving mode. Auto-Cruise will also be deactivated when the "Set" switch is pressed, if the brake fuse burns out, or if the speed is much lower than the set speed.

**Prevent Abnormal Acceleration** Our safety design uses a microcomputer to monitor two kinds of output signal and if an abnormality is sensed will return to normal driving mode to prevent abnormal acceleration.

Example of speed difference test **59<sup>+1</sup><sub>-0</sub> km/h**

Example of fuel consumption test

AUTO CRUISE 60km/h	<b>12.4 km/L</b> (121 cc)
Variable Speed Driving 55–65 km/h	<b>9.9 km/L</b> (151 cc)
Variable Speed Driving 50–70 km/h	<b>8.2 km/L</b> (183 cc)

These figures were obtained through a driving test and may be different from results on actual road conditions.

- WAGON R (MH23S) · Road grade: Upward slope of approx. 1.5 degrees
- Running distance: 1.5 km

Note: Variable speed driving was obtained by accelerating up and down around the set speed.

### SPECIAL MODEL SPECIFIC HARNESS

3-drive ▶ 3-drive

The car specific harness makes connection to the electronic accelerator a snap; for those already using a 3-drive Series product this can be used as is (for Japanese cars).

## THROTTLE CONTROL

### SPORTS & ECO

**SPORTS & ECO** 3-drive enables both the "raising" and "lowering" of response to acceleration in electronic throttle car models, giving the driver control over acceleration response for both sports driving and Eco-driving.

**12-Step Adjustment** A wide variety of possible adjustments to meet your need; 7 for Sports and 5 for Eco.

**Acceleration Monitor** This shows the amount of acceleration; especially useful when trying to be careful about not over accelerating as in Eco-driving.

### Performance Results of Each Mode (0-400 m)

· HONDA STEP WGN (RG1)

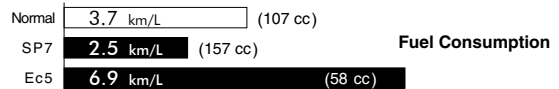

### AT Gear Position Pattern · VW GOLF GTI (1KAXX)

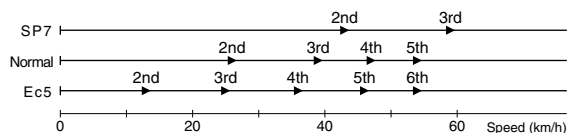

SP7: MAX. SPORTS Mode Ec5: MAX. ECO Mode Degree of acceleration: 30%  
Note: In models with CVT or in which changes in speed bring less shock, the noticeable differences may be less.

### Examples of Changes in Throttle Opening · SUZUKI SWIFT (ZC31S)

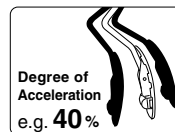
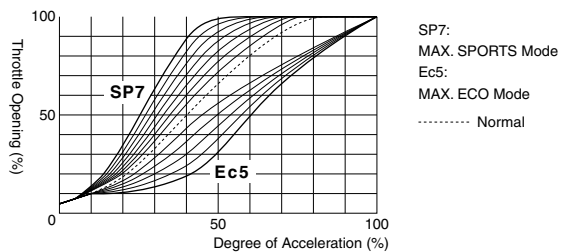

■ Air Intake  
○ Throttle Valve

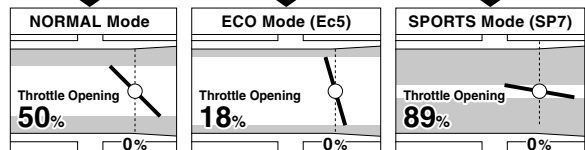

Note: In some car models with a Valvematic engine, control is carried out by the exhaust valve rather than the throttle valve.

Before Using

Features

Connecting The Wires

Installing The Product

Initial Settings

Speed Pulse Settings

How to Operate

Trouble-Shooting

## Part Names

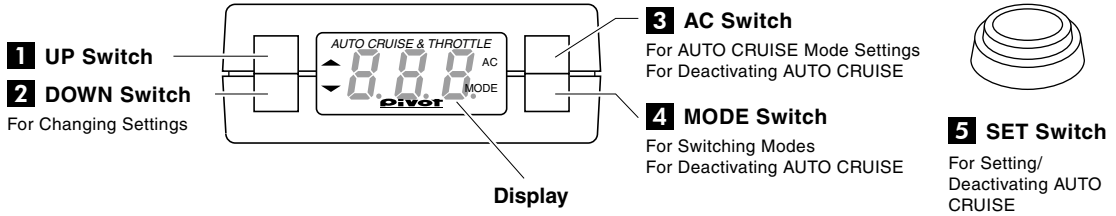

### Turning off the Display

This product is interlocked with the ECU (engine computer) power. Depending on the model of car, the display may remain on for up to 15 minutes even after the ignition has been turned to the OFF position; this is normal.

## Display Items

### Display Items

Display	Details
SP1-SP7	SPORTS Mode (higher number = higher response)
EC1-EC5	ECO Mode (higher number = lower response)
nor	NORMAL (Normal Performance)
R00	Degree of Acceleration
on.	AUTO CRUISE Mode: ON
off	AUTO CRUISE Mode: OFF
Rcc	AUTO CRUISE in Operation
bRc	Reverse (when in SPORTS Mode only)

### Display for Settings

Display	Details
cAr	Initial Settings Mode
L00	Position when accelerator is not pressed down.
H00	Position when accelerator is fully pressed down.
SET	Settings Completed
PLS	Speed Pulse Setting Mode
P-0	Speed Pulse Number
L-0	Adjust AUTO CRUISE Level

### WARNING

Improper use or disregard of these warnings may result in the injury or death of people.

- When making initial settings make sure to stop the engine and place in Parking or Neutral. It is dangerous to carry out these settings while the engine is running.
- Do not work in areas where there is excessive exhaust. Due to vehicle exhaust emission poisoning or fire may result in a damage to humans.
- Do not crush the cable. Please be careful that the cable does not get crushed by the seat rail or car door steel plate, nor cut by any sharp steel plate as this may cause a poor connection or an electric short leading to fire or other danger.
- While driving DO NOT operate switches or pay prolonged attention to the display; it is extremely dangerous.
- Make sure that all wiring and fastening down of the product does not interfere with driving nor be done in such a way as to cause poor connections.

### CAUTION

Improper use or disregard of these warnings may cause injury to persons, damage the product and/or other things.

- PIVOT Corporation accepts no responsibility, in any manner whatsoever, for damage and/or trouble to your vehicle or product, nor for any accidents that are the result of the misuse of this product.
- Please confirm that the type of vehicle you wish to install into is listed in the "list of Specialized Harnesses by Car Model for 3-drive • AC".
- When installing this product, we recommend that if technical knowledge becomes necessary please consult a qualified mechanic.
- If the device is improperly installed or settings have been improperly made a Check Engine Light may go on.
- Do not use electrotap.
- Wiring should be carried out using the attached "cut connector" or by soldering, make sure to securely insulate all wiring parts with insulation tape, and confirm that no wires are sticking out.
- Please wipe with a soft dry cloth (a lens cloth).
- Please do not use alcohol or benzene. This may cause damage to the painted surface or cracks in the plastic.
- Do not, in any manner, process, take apart, or make changes to this product.

Before Using

Features

Connecting The Wires

Installing The Product

Initial Settings

Speed Pulse Settings

How to Operate

Trouble-Shooting

# procedure 1

## Connecting The Wires

### Basic Wiring When installing make sure to use the correct Specialized Harness for your car model.

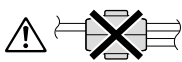
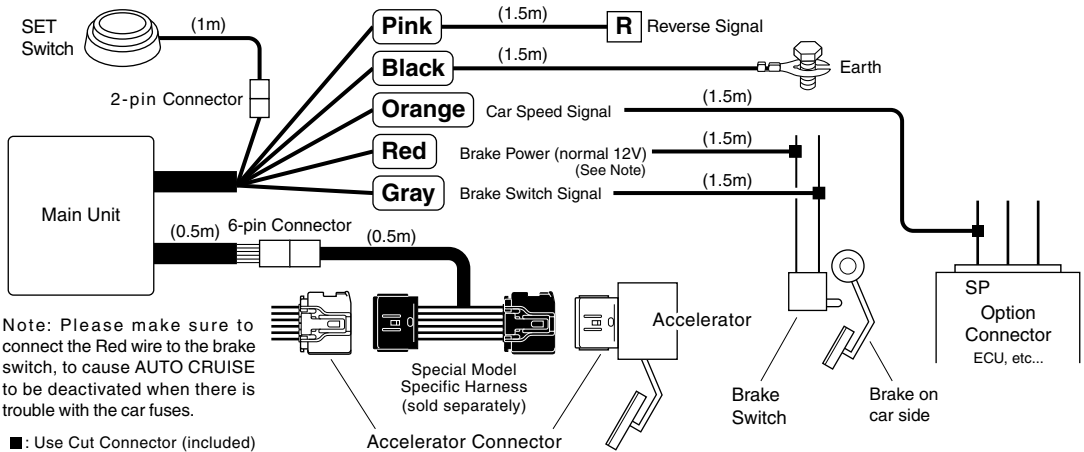

• When connecting to the car side wires, do not only use “electrotap” as this may result in a poor electrical connection. Please use the supplied “cut connectors” or solder the wires together and make sure to use insulation tape to securely insulate the wire connection.

- The Brake Switch Connectors will differ depending upon the car model, grade and year, so please sure to check the design in the “Wiring Chart” .
- Remove the battery cables from the minus terminals before carrying out the wiring.

### Brake Switch (Brake Power and Brake Switch Signal)

- Red** To brake Power (normal 12V)
- Gray** To brake Switch signal

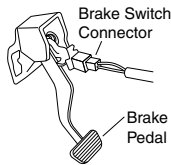

- There may be two or four (or more) wires coming from the brake switch connector. Check the wiring position in the “Wiring Chart” and after testing the voltage, carry out the wiring.
- After having completed the wiring confirm that the brake lamp is working properly.

#### For a Two-Wire Connector

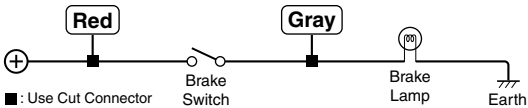

#### For a Four (or more)-Wire Connector

When there are four (or more) wires, do not wire to positions A and B as shown below. (See below for how to check the voltage for each wiring position)

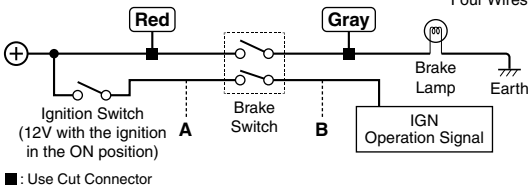

#### How to Test (⇒Refer to page 5 [Reference 1] “How to use the Voltage Detector”)

1. Turn the ignition to the OFF position. Please put gear into P (Parking) or N (Neutral).
2. Check the terminal for each of the connections as designated in the separate sheet “Wiring Chart” .

The Wire color of the product	Not Press Down on Brake Pedal	Press Down on Brake Pedal	
<b>Red</b>	☀ (12V)	☀ (12V)	Brake power
<b>Gray</b>	○ (0V)	☀ (12V)	Brake switch signal

☀: Voltage Tester Lamp ON ○: OFF

If there are four (or more) wires, do not wire the remaining (OFF 0V).

### Select a Wiring Method

Select from either “Connect Directly” or “Connect using Brake Harness” and carry out directions as stated.

1. After having tested voltage at the positions to be wired, connect as directed.
2. In case of the car model which is blank of Wire Numbers or Brake Harness Connection Color of “Wiring Chart” , please make sure to carry out a voltage test and connect as directed.

### Connect Directly

Connect the Red and Gray wires to the corresponding wire numbers found in the “Wiring Chart” which is included.



(⇒Refer to page 5 [Reference 2] “How to use the Cut Connectors”)

⚠ **Note that the colors listed in the chart under “Brake Harness Connection Color” are not the colors of the wires on the car side.**

e.g.) TOYOTA ALPHARD (from May 2008)

TOYOTA

車名	年式	ブレーキハーネス品番	直接接続 接続番号				ブレーキハーネス接続色	Connection Numbers
			製品のコード色					
アルファード・ヴェルファイア	H20.5~	BR-1	赤	灰	赤	灰	① ②	青 黄
			①	②	①	②		

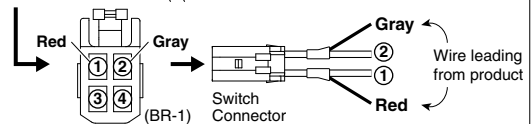

### Connect Using Brake Harness (sold separately)

Connect the Red and Gray wires to the corresponding wire colors found in the “Wiring Chart” .



(⇒For more details , please refer to the brake harness manual.)

e.g.) TOYOTA ALPHARD (from May 2008)

TOYOTA

車名	年式	ブレーキハーネス品番	直接接続 接続番号				ブレーキハーネス接続色	Connection Colors
			製品のコード色					
アルファード・ヴェルファイア	H20.5~	BR-1	赤	灰	赤	灰	1 2	青 黄
			①	②	①	②		

## Car Speed Signal

**Orange**

Confirm the positions on the "Wiring Chart" and then connect using Cut Connectors.

(⇒ Refer to "[Reference 2] How to use the Connector" below.)

Wiring Chart

Note: Some MITSUBISHI, SUZUKI and NISSAN models require a separate speed pulse adapter.

Connect only to the cables on the car side as directed. (Do not wire the speed signal to the CAN-BUS adaptor.)

## Earth

**Black**

with earth terminal

Fasten to a screw of a metal part which is earthed.



Note: Painted screws and screws connected to plastic parts are not earthed; make sure to connect only to a place which is earthed.

## Special Model Specific Harness (sold separately)

**6-pin Connector**

Connect to the 6-pin connector on the specialized harness.



Only disconnect the accelerator connector after having waited at least 15 minutes from the time that the ignition was turned to the OFF position.

Depending on the type of vehicle, if the connector is disconnected before the ECU power is switched OFF the Check Engine Light may go on. (If the Light comes on: ⇒ Refer to Page 12, "How to Turn Off the Check Engine Light")

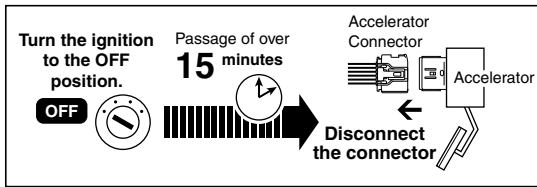

Note: For details about connecting the specialized harness, please refer to the user's manual that came with that harness. If the cable is not long enough, use the extension cable "THC-EC (sold separately for ¥1,500)".

## SET Switch

**2-pin Connector**

Connect to the 2-pin connector leading from the unit.



## Reverse Signal

By wiring to reverse, it is possible when in SPORTS Mode to automatically switch to NORMAL Mode when the gear is put into R (Reverse). Also, during this time it will become impossible to set to AUTO CRUISE.

Note: When put into reverse, the degree of acceleration is small and quick acceleration will not occur; it is not necessary to wire for reverse.

This does not operate when in ECO Mode or NORMAL Mode.

**Pink**

• Gear Position

When in R (Reverse) = 12V, other positions = 0V

(How to Test) With the ignition switched to the ON position (engine not operating) put gear into reverse.

(How to Wire) Cut the black tube of the wire tip and connect referring the diagrams below.

### If wiring to the Reverse Signal

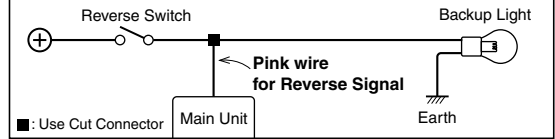

### If wiring to the optional connector of the car maker's original navigation system

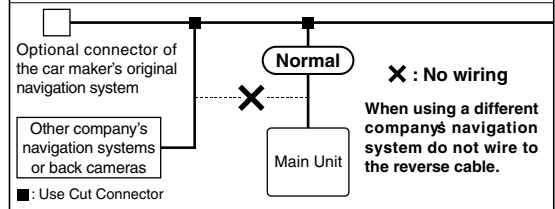

### (Check Wiring)

If in SPORTS Mode, when the reverse signal is input the display will read "bAc" and the unit will switch to NORMAL Mode.

bAc



Wiring for when you wish not use AUTO CRUISE

**Red**

Normally 12V (OK for other than brake)

**Black**

Earth

**Gray**

**Orange**

Do not connect to anywhere

## [Reference 1] How to use the Voltage Detector (supplied with product)

- Loosen an earthed screw, insert and fasten the wire tip (coiled wire).



Note: As an earthing screw, only use a screw that is fastened to a metal part. Painted screws and screws connected to plastic parts become insulated and cannot carry electricity.



In some car models, voltage detector which is supplied with product doesn't work because of the current capacity shortage. Please use analog multimeter and others in this case.

- Connect the tip of the LED to the place you wish to test voltage.

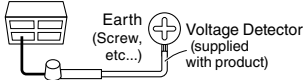

Lamp on : 12V  
Lamp off : 0V

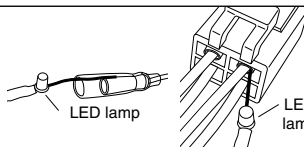

## [Reference 2] How to use the Connectors

1

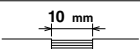

Peel off of the vinyl cover at connection.

2

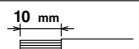

Peel off of the vinyl cover at the end of the product's wire.

3



Wrap around both wire coils.

4

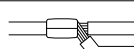

Close tightly with cut connector.

5



Insulate with vinyl tape.

When crimping, please use crimpers or use pliers to bend and then solder together.

Before Using

Features

Connecting The Wires

Installing The Product

Initial Settings

Speed Pulse Settings

How to Operate

Trouble-Shooting

## procedure 2

# Installing The Product



**Do not use magnetic holders, such as for a smartphone, to prevent malfunction.**



**Please be sure to bundle away all wires with tape not to get damaged by any steel plate or screws as this may cause short circuit.**

### Installing The Main Unit

Install the Main Unit to a position which is easy to see.

#### (How to Install)

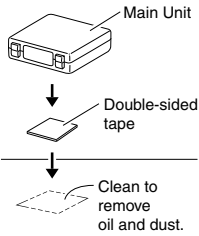

#### (Example of Installation)

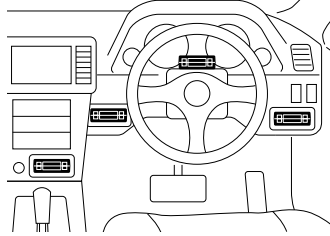

### How to Use Mounting Stay

By using the Mounting Stay that comes with this product, it is possible to install the unit on the dashboard even if it is curved or on an angle.

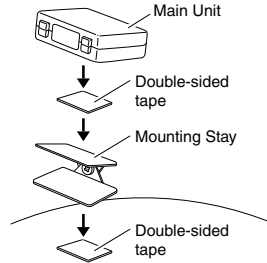

Note: It is possible to install the Mounting Stay in the reverse direction.

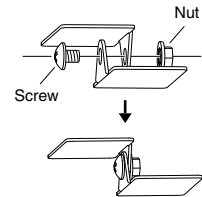

### Installing The SET Switch

Install the SET switch to a position which is easy to operate.

#### (How to Install)

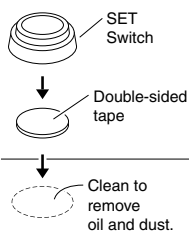

#### (Example of Installation)

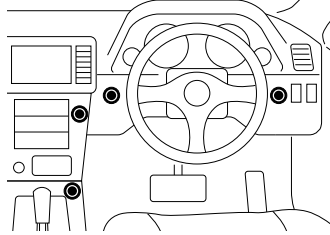

If you wish to install the switch to a round shaped lever, please purchase separately a Lever Spacer.

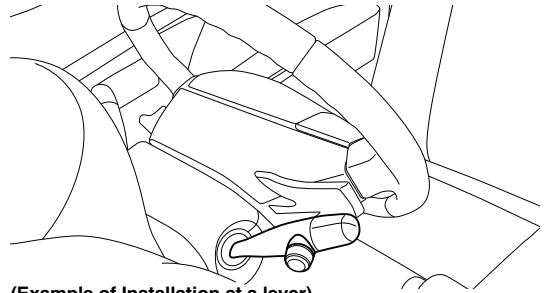

(Example of Installation at a lever)

### ●Lever Spacer Set (17, 26, 28, 32mm) ; Sold separately for ¥762

#### (How to Install)

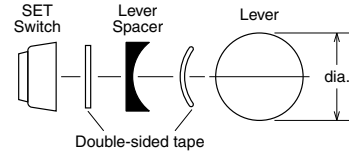

#### (Example of the Spacer Installation)

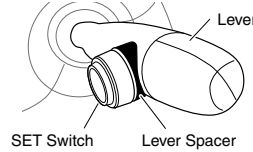

#### Shapes for which Installation is Possible

It is not possible to install to levers which have fog lamp switches or wiper switches and do not have 22 mm of space or more. (However, it is possible to install to levers which do not have 22 mm of space or more for some NISSAN or HONDA car models.)

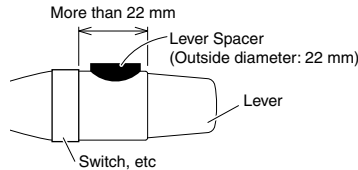

#### [Lever Diameters of Major Car Models]

Lever Diameter	Type of Car
17 mm	STEP WGN, FREED
26 mm	WAGON R, HIACE, SWIFT
28 mm	PRIUS, VELLFIRE
32 mm	FIT, DEMIO (DE), SERENA

Note: For other car models, please measure the lever diameter before purchasing.

#### About Fastening Wires Down

Fasten down the cable from the switch using the Zip tie which is supplied with the spacer. And cut excess Zip tie.

Note: When pulling the cable into the column cover, be careful not to crush or smash it.

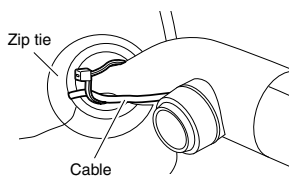

#### When Pressing In On The Switch

Use your thumb to keep the lever from moving and press in on the switch.

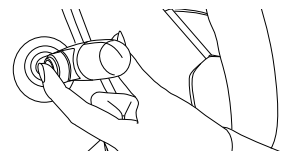

**procedure 3**

# Initial Settings (Degree of Acceleration Setting)

Make sure to carry out these settings.

When installing for the first time



**Initial Settings**

When installing into a different car













**Initial Settings**







- This operation sets the car's accelerator characteristics into the controller unit.
- If the "Initial Settings" are not carried out, the unit will remain in NORMAL Mode even if the Mode is switched.
- If this settings have been improperly made a Check Engine Light may go on.



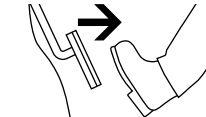

## Before making the "Initial Settings"

1. Make settings only after having completed all wiring (connector installation).
2. Make settings with the ignition in the ON position (engine not running) and the gear in **P** (Parking) or **N** (Neutral).

### [Making the Settings]

Operational Procedure	Main Unit Display Area
<b>1</b> Turn the ignition to the ON position. (Engine not running)  or  Without braking, press down twice	nor. or nor (nor Display)  If nor does not appear, press the MODE switch until nor appears.
<b>2</b> Press the UP switch for 10 seconds or longer to change the display to "0".  Press until "0" appears	"cAr" Blink  -5- -4- ... -0- Count down from 5 to 0 after the "cAr" blink.
<b>3</b> When "0" appears release the UP switch.  Release	(e.g.) (See Note 1) L1.5 Voltage Display (e.g., L1.5)
<b>4</b> Pedal is not pressed down. (Release the accelerator to 0%) 	(e.g.) (See Note 1) L1.5 Voltage Display (e.g., L1.5)
<b>5</b> Press the UP switch.  Press  Set to 0%	SEt (SEt Display)
<b>6</b> Pedal is completely pressed down. (Press in on the accelerator to 100%) 	(e.g.) (See Note 1) H4.5 Voltage Display (e.g., H4.5)

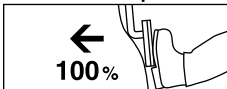
Operational Procedure	Main Unit Display Area
<b>7</b> With the accelerator at 100%, press the UP switch.  Press  Set to 100%	SEt (SEt Display)  nor. or nor (nor will be displayed for 1 second)  100 (100 Display)
<b>8</b> Once the display changes to 100 release the accelerator. 	100 (100 Display)  nor. or nor (nor Display)
<b>9</b> <b>Setting Completed</b> If the device is re-installed into a different vehicle, make sure to carry out these settings again.  After having finished settings and the battery or wires have been disconnected it is not necessary to carry out "Initial Settings".	

Check the Settings	Note: If the display is incorrect start again from step 2 above.
Do not press in on pedal  	nor. or nor (nor Display)
Press down on pedal  	100 (100 Display)
Note: Depending on characteristics of the accelerator or on how the accelerator is stepped on the display may read "A95" (95%).	

 If Err is displayed at **7** If after the "Err" is shown the display returns to as shown in **4** ("L1.5" or so on), it means that the degree of acceleration settings have not been confirmed properly. Re-do the settings from step **4**.

Note 1: The values shown in the display will vary depending on the type of car.

Before Using

Features

Connecting The Wires

Installing The Product

 Initial Settings this operation. Make sure to carry out

Speed Pulse Settings

How to Operate





Trouble-Shooting

**procedure 4**

# Speed Pulse Settings

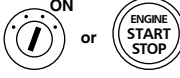
For details about Pulse settings, see the "Wiring Chart".

## [Making the Settings]

Operational Procedure	Main Unit Display Area
<p><b>1</b> Turn the Ignition ON. (Engine not running)</p>  <p>Without braking, press down twice</p>	<p><i>nor.</i> or <i>nor</i> (nor Display)</p> <p>⚠ If <i>nor</i> does not appear, press the MODE switch until <i>nor</i> appears.</p>
<p><b>2</b> Press the DOWN switch for 3 seconds or longer.</p>  <p>Press the switch for 3 seconds</p>	<p><i>PLS</i> (PLS Display)</p>
<p><b>3</b> Release the DOWN switch and the pulse setting will appear.</p>  <p>Release</p>	<p><i>P 0 0</i> (Pulse Number Display)</p>
<p><b>4</b> Press the UP / DOWN switches to select the desired pulse setting.</p>  <p>UP / DOWN Press</p>	<p><i>P - 2</i> ↔ <i>P - 4</i> (Factory Setting)</p> <p>↑</p> <p><i>P 1 6</i> ↔ <i>P - 8</i></p>

Operational Procedure	Main Unit Display Area
<p><b>5</b> Do not operate any switches for 10 or more seconds.</p>	<p><i>P 0 0</i> (The selected pulse setting will blink)</p> <p>↓</p> <p><i>P 0 0</i> (The selected pulse setting will light up)</p> <p>↓</p> <p><b>Display is Off</b></p>
<p><b>6</b> Returns to NORMAL Mode.</p>	<p><i>nor.</i> or <i>nor</i> (nor Display)</p>
<p><b>7</b> Setting Completed</p>	

⚠ If AUTO CRUISE can not be set when the speedometer reads 50 km/h or higher, or if it can be set when the speedometer is at 20km/h or lower, then the Pulse Setting is incorrect; please check and change.

## Basic Operation

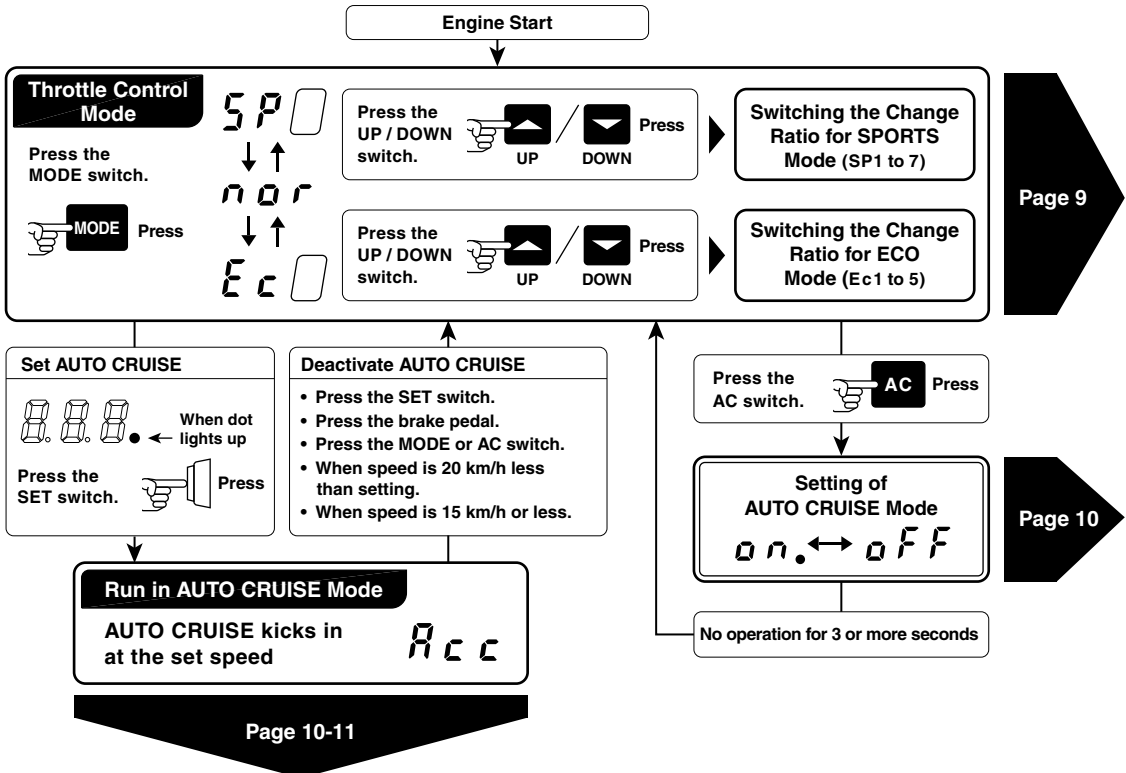

Before Using  
 Features  
 Connecting The Wires  
 Installing The Product  
 Initial Settings  
 Speed Pulse Settings  
 How to Operate  
 Trouble-Shooting



# Degree of Acceleration Monitor

Displays the amount of pressure placed on the accelerator pedal. (output signal)[15-100%, 5% unit]

Degree of Acceleration Monitor shows the rate of acceleration output to the ECU where 0 represents the pedal not being pressed in and 100 equals when the pedal is fully pressed down.

Note: When in ECO Mode, even if the accelerator is stepped on a full 100% the output signal will only be 80%.

Depending on characteristics of the accelerator or on how the accelerator is stepped on the display may read up to 95%. (when in SPORTS Mode and NORMAL Mode only)

## USE 1 Check acceleration during ECO driving

To ensure reduced fuel consumption during acceleration the degree of acceleration should be between 15% and 25%. To further improve results use ECO Mode when wishing to save fuel.



## USE 2 Check acceleration during regular driving

Please use to check the degree of acceleration for any type of driving, not just ECO Mode.

## USE 3 Check control status

With the ignition in the ON position and under NORMAL Mode press in the pedal until it reaches 40% (A40), if the Mode is changed to SP7 the display should read 65% (A65) and if placed in Ec5 the display should change to 20% (A20).

[See the above Graph of "Basic Control Features" ] Note: The actual display may differ slightly.

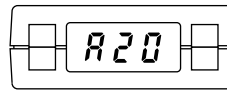

Degree of Acceleration (output) 20%

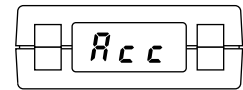

While in AUTO CRUISE (no degree display)

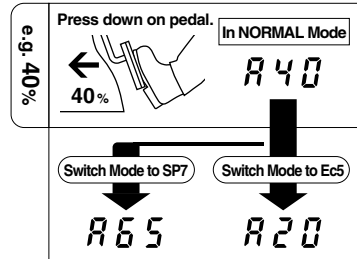

# Operating the Throttle Controller

## Switch the Mode

Switch between three modes: SPORTS Mode (Higher Response), ECO Mode (Lower Response), and NORMAL Mode (Standard Performance).

**1 Engine START.**

**2 The Mode will change with each pressing of the MODE switch.**

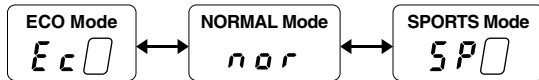

Note: For safety, when changing modes always go through **nor** (NORMAL) one time.  
**About the Relay sound**  
When switching to **nor** for safety reasons the relay will go into operation and you will hear a clicking sound.

## Adjust the Change Ratio for each Mode

Switch the change ratios within SPORTS Mode (SP) and ECO Mode (Ec).

⚠ When making adjustments to the change ratios, begin at the lowest setting and slowly make changes while continually checking acceleration.

**Ec** is displayed, the ratio will change with each pressing of the UP / DOWN switch.

**SP** is displayed, the ratio will change with each pressing of the UP / DOWN switch.

### Switching the Change Ratio for ECO Mode

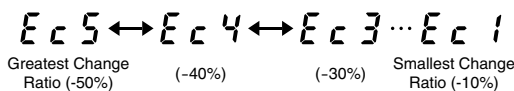

### Switching the Change Ratio for SPORTS Mode

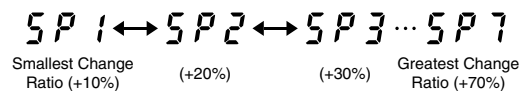

## ⚠ Saving Settings

All settings are saved even after the ignition has been turned to the OFF position. However, if the ignition is turned to the OFF position in 2 seconds or less after the last setting operation was carried out, the settings will not be saved.

## [Reference 1] Examples of changes in fuel consumption and response depending on change ratios

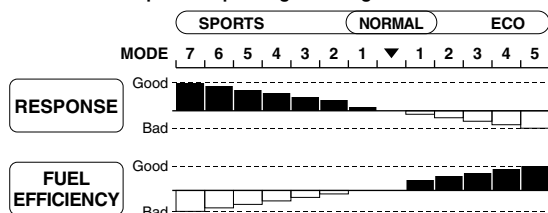

Note: In ECO Mode, because response is less than the standard fuel efficiency can be improved. However, if rapid acceleration is purposefully carried out fuel efficiency will be reduced.

The changes in response will be greater as the vehicle's power is greater.

## [Reference 2] Basic Control Features

The changes throughout each Mode will be controlled smoothly without perceptible steps.

Acceleration output signal based on amount of pressure placed on accelerator pedal

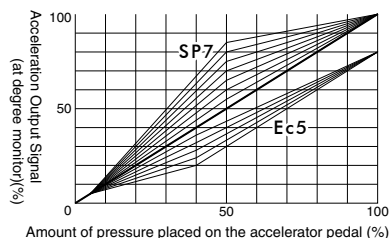

Before Using

Features

Connecting The Wires

Installing The Product

Initial Settings

Speed Pulse Settings

How to Operate

Trouble-Shooting

# Operating the AUTO CRUISE

After setting to AUTO CRUISE, you can drive automatically at the set speed even without pressing down on the accelerator pedal.

- AUTO CRUISE is nothing more than an aid to assist drivers. Please make sure to follow all speed limits and practice safe driving.
- AUTO CRUISE can be dangerous if activated in the following conditions; do not use under these conditions.
  - (1) On slippery Roads (snow and ice) (2) In traffic jams
  - (3) Around sudden curves and/or slopes
- Upon climbing a sudden slope, it is not possible to accelerate beyond the capability of the engine. Moreover, when going down a sudden decline the engine can not force deceleration other than from the engine brake; please use the brake when necessary.
- To avoid an increase in engine revolutions, do not put the gear in N (neutral) or any other gear other than D (drive) while in AUTO CRUISE.

**[Settable Speed]**  
Approximately  
30~140 km/h

Due to differences in some standard meters, the setting will fall in the range of between 35 and 145 km/h.

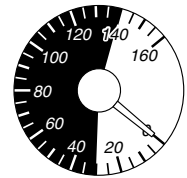

## Mode Setting

Use the SET switch to turn AUTO CRUISE to ON or OFF.  
Note: All settings are saved even after the ignition has been turned off.

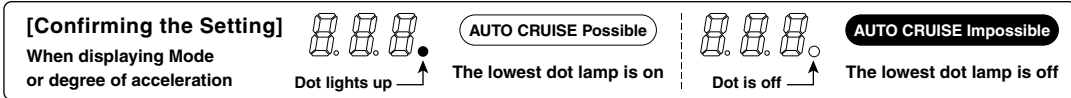
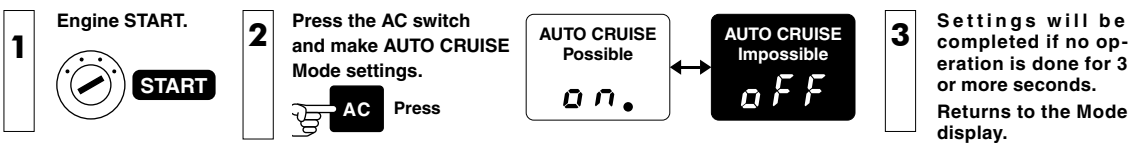

⚠ If you wish not to use AUTO CRUISE, please turn the AUTO CRUISE Mode to OFF.

## Set and Deactivate

### [Making the Settings]

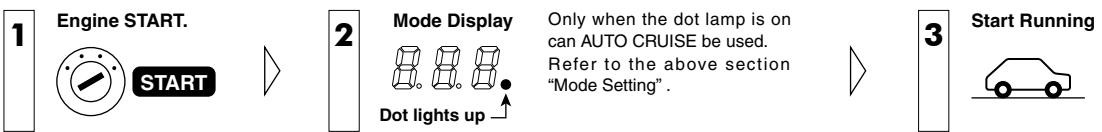

**4 When at the desired speed press in on the SET switch.**  
Please try to set when there is as little change in speed as possible.

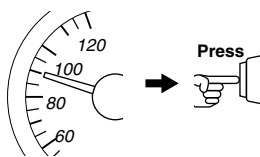

⚠ **When setting make sure not to quickly depress the accelerator.**  
• When setting during a sudden hill climb the car will run more stably after decelerating a little.

**About the Relay sound (clicking noise)**  
If you set under NORMAL Mode *n o r*, you will hear a noise from the relay working. If this bothers you, please set while in *S P i* or *E c t*.

**5 AUTO CRUISE kicks in at the set speed**  
When in Acc, do not depress the accelerator for any other reason than for acceleration.

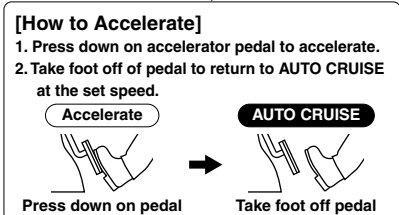

**[How to Deactivate]** AUTO CRUISE can be deactivated using any of the following:

- Press the SET switch.
- Press the brake pedal.
- Press the MODE / AC switch.

**[Auto-Deactivation]**

- When speed declines to 20 km/h or less than the set speed.
- When the speed declines to 15 km/h or less.



**Returns to Step 3.**  
Mode Display  
Dot lights up

**[How to Reset]** After deactivation occurs, carry out as in step 4.

## Adjust Level

Depending on the size of your car's engine the amount of time it takes to return to the set cruising speed after a hill climb or other such condition will differ. By adjusting the level it is possible to change the amount of time for returning to the set cruising speed to be faster or slower to match your car's performance and desired ride.

**Level adjustments may differ depending on car model or driving conditions; please use the following as a simple guideline and adjust to fit your needs.** (The factory default setting is L-3)

<b>Up to L-5</b> (Quick Acceleration) <b>For Smaller Engines</b>	In car models with smaller engines, to have the car return to the set speed faster raise the level to L-5.	<b>Quicker Return</b> 	L-5 ↑ L-4 ↑ L-3 (Factory Setting) ↓ L-2 ↓ L-1	<b>For Smaller Engines</b> <b>Quick</b> (Lessen difference in returning to speed) ↑ Amount of Time to Return to Set Cruise Speed ↓ <b>Slow</b> (For more comfortable return to speed) <b>For Larger Engines</b>	<b>[Setting Examples]</b> L-5 ALTO L-4 MARCH, FIT, DEMIO, WAGON R L-3 VOXY, PRIUS, CARAVAN, SERENA, INSIGHT, STEP WGN, SWIFT L-2 VELLFIRE, CROWN, HIACE, ELGRAND, LAGACY, MPV
<b>Down to L-1</b> (Slow Acceleration) <b>For Larger Engines</b>	In larger engine car models, to have the car ride more comfortably without sudden acceleration to return to the set speed, lower the level to L-1.	<b>Slower Return</b> 			



**Operating switches or checking the display while driving may cause accidents; please use with the utmost consideration for safety.**

### [Making the Settings]

**1** While Running in AUTO CRUISE Mode



**2** Pressing the switch will display the current level and by pressing UP /DOWN you can switch levels.



Change the AUTO CRUISE Level

L-1 ↔ L-2 ↔ L-3 ↔ L-4 ↔ L-5

Low Level (Factory setting) High Level

### Test Drive

After having carried out all of the necessary wiring and making settings in "Initial Settings" and "Speed Pulse Settings" please carry out a low-speed test run.



- Please carry out the test drive in a safe spacious area away from pedestrians and traffic.
- Please make sure to carefully read this manual and understand how to operate the unit before taking a test run.

**1** Engine Start.



**2** Press the AC switch and make AUTO CRUISE Mode on.



**3** Settings will be completed if no operation is done for 3 or more seconds.



**4** AUTO CRUISE Mode: ON

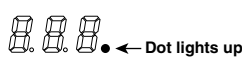

**5** Start the Test Run (35-40 km/h)



**6** Press the SET switch.



**7** AUTO CRUISE kicks in at the set speed



#### Deactivating AUTO CRUISE



- Press the SET switch.
- Press the brake pedal.
- Press the MODE / AC switch.

#### AUTO CRUISE does not Operate

- Poor connection of Gray and Orange wires. (⇒Page 4-5)
- Improper wiring of Pink wires. (⇒Page 5)
- Respective settings have not been completed. (⇒Page 7-8)
- Poor connection of SET switch connector (⇒Page 5)

## Troubleshooting

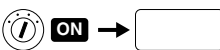
### Concerning Basic Operations and Car Problems

Trouble	Possible Causes	Possible Solutions
The ignition is set to the ON position but the display of the Main Unit will not light up. 	Brake fuse is burned out. The <b>Red</b> and <b>Black</b> wires may have been improperly wired or there is a poor connection. Poor connection of <b>Specialized Harness</b> and <b>6-pin Connector</b> .	Please reconfirm whether wiring and connections are correct or not.
A Check Engine Light has gone on. 	The accelerator connector was disconnected within 15 minutes after having turned the ignition to the OFF position. The "Initial Settings" have not been properly carried out. With the ignition in the ON position disconnect <b>Specialized Harness</b> or <b>6-pin Connector</b> .	Connect to Accelerator Connector(See page 4-5 of this Manual) , and turn off the Check Engine Light (See page 12). Make the "Initial Settings" (See page 7 of this Manual) , and turn off the Check Engine Light (See page 12). Re-connect the disconnected connector and turn off the Check Engine Light (See page 12 of this Manual).
The engine has been turned OFF but the display remain on.	This product is interlocked with the ECU (engine computer) power. Depending on the model of car, the display may remain on for up to 15 minutes even after the ignition has been turned to the OFF position; this is normal.	

Before Using

Features

Connecting The Wires

Installing The Product



Initial Settings

Speed Pulse Settings



How to Operate

Trouble-Shooting















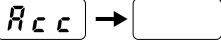

## Concerning Basic Operations and Car Problems (Continuation of the previous page)

Trouble	Possible Causes	Possible Solutions
While making "Initial Settings" an Err appears in the display. 	The "Initial Settings" have not been properly carried out.	Make the settings by following the directions under  "Initial Settings" found on Page 7 of this Manual.

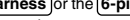
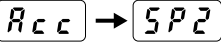
## Concerning the Throttle Controller

Trouble	Possible Causes	Possible Solutions
Even if the Mode is changed, the changes cannot be felt.	The "Initial Settings" have not been properly carried out.	Make the settings by following the directions under  "Initial Settings" found on Page 7 of this Manual.
The Mode and/or the setting of change ratios can not be saved.	The ignition has been turned to the OFF position immediately after having finished the setting of change ratios or changing the Mode.	After having made settings of change ratios or changing the Mode, wait for at least two seconds before turning the ignition to the OFF position.
While in SPORTS Mode, when put into reverse the display does not show "bAc". 	<p>The  wire may have been improperly wired or there is a poor connection.</p> <p>The unit is connected to the reverse wire of a navigation system from another company.</p> <p>The backup lights have been changed to LED lamps.</p>	<p>Please reconfirm whether wiring and connections are correct or not.</p> <p>Follow the instructions for wiring to reverse found in this Manual (See page 5).</p> <ul style="list-style-type: none"> <li>• Replace the backup lights with the car maker's original lights.</li> <li>• Do not carry out wiring for Reverse Gear.</li> </ul>

## Concerning AUTO CRUISE

Trouble	Possible Causes	Possible Solutions
AUTO CRUISE does not Operate. 	<p>The  and  wires may have been improperly wired or there is a poor connection.</p> <p>Poor connection of .</p> <p>The  wire may have been improperly wired.</p> <p>The setting is outside the allowable range.</p> <p>AUTO CRUISE Mode is turned OFF. (dot is off)</p>	<p>Please reconfirm whether wiring and connections are correct or not.</p> <p>Please refer to Page 10 of this manual "Mode Setting" to turn the dot lamp ON.</p>
	<p>The "Initial Settings" have not been properly carried out.</p> <p>The brake lamp bulbs have been changed to LED lamp bulbs.</p> <p>During quick deceleration due to slowness in the gauge it may not operate even though the speed is over 30 km/h.</p>	<p>Make the settings by following the directions under  "Initial Settings" found on Page 7 of this Manual.</p> <p>Replace with standard brake lamp bulbs.</p>
After AUTO CRUISE is deactivated the display goes off. 	<p>Brake fuse is burned out.</p> <p>The  and  wires may have been improperly wired or there is a poor connection.</p> <p>The  or the  has become disconnected.</p>	<p>Please reconfirm whether wiring and connections are correct or not.</p>
AUTO CRUISE is automatically deactivated and the display switches to throttle controller. 	<p>The  and  wires may have been improperly wired or there is a poor connection.</p> <p>The  wire may have been improperly wired.</p> <p>The "Initial Settings" have not been properly carried out.</p> <p>AUTO CRUISE will be automatically deactivated if the speed declines to 20 km/h or less than the set speed or if the speed declines to 15 km/h or less.</p>	<p>Please reconfirm whether wiring and connections are correct or not.</p> <p>Make the settings by following the directions under  "Initial Settings" found on Page 7 of this Manual.</p>
When climbing a hill, the speed is much slower than the set cruise speed.	The AUTO CRUISE Level has been adjusted to a lower level (lowest is L-1).	For details about adjusting see Page 11 of this manual "Adjust Level".
It feels like to return to the AUTO CRUISE speed is too quick and jumpy.	The AUTO CRUISE Level has been adjusted to a higher level (highest is L-5).	
Even at speeds above 30 km/h AUTO CRUISE does not kick in.	"Speed Pulse Settings" have not been properly carried out.	Make the settings by following the directions under  "Speed Pulse Settings" found on Page 8 of this Manual.

**Note**

### How to Turn Off the Check Engine Light

- If the Check Engine Light comes on due to some operational mistake, follow the directions below to turn it off.
1. Under normal conditions, start and stop the engine several times.
  2. If that does not turn off the lamp, disconnect the cable from  terminal of the battery for about 10 minutes.
  3. If that does not turn off the lamp, please consult your local car dealer and have them turn it off.

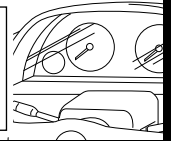
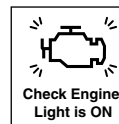

**(Note)** • Our products have already been recognized as our Industrial Property or are in the process of receiving Industrial Property status.  
 • We plan in the near future to take all possible legal measures to protect against unfair competition from look-alike products using similar designs, regulating characteristics, circuitry and circuitry layout.  
 • We strictly prohibit the unlicensed use of the PIVOT trademark and the unauthorized use of PIVOT User's Manual.