

The Future of Cyber Gauges is Here and Now.

USER'S MANUAL

CYBER GAUGE OBD or SENSOR SYSTEM

Sensor Connection

BOOST **CSB**

Thank you for purchasing this PIVOT product.
Please read this manual carefully and keep it for future reference.

- If this product is given to another user, make sure to include this User's Manual.

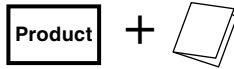

Contents

Contents / WARNING / CAUTION 1
 Features 2
 Part Names and Displays 2
 Connecting The Wires 2
 Installing The Product..... 3
 Basic Operation 3
 Switching The Display and Setting 3~4
 Troubleshooting 4

Please check the contents of the package

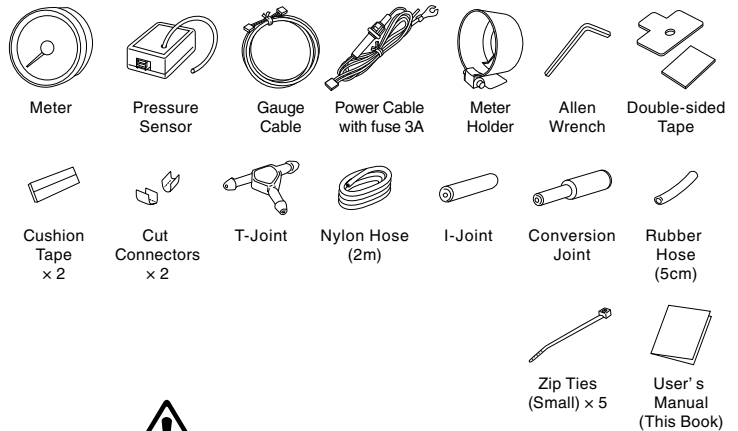

⚠ WARNING

Improper use or disregard of these warnings may result in the injury or death of people.

- **Do not work in areas where there is excessive exhaust.**
Due to vehicle exhaust emission poisoning or fire may result in a damage to humans.
- **Do not crush the cable.**
Please be careful that the cable does not get crushed by the seat rail or car door steel plate, nor cut by any sharp steel plate as this may cause a poor connection or an electric short leading to fire or other danger.
- **Do not operate while driving.**
Operating or checking the display during driving may cause an accident; please use with the utmost consideration for safety.
- **Please securely fasten the product and be sure to store bundle away all wires with tape, etc...**
It is very dangerous to pull tangled wires by force or allow tangled wires to interfere with driving.

⚠ CAUTION

Improper use or disregard of these warnings may cause injury to persons, damage the product and other things.

- **This product is for DC12V cars;**
Installation cannot be carried out on cars with other voltage batteries.
- **Just after installation do not exert any strong force on the product.**
When double-sided tape is used for an installation be warned that when hot the tape temporarily loses adhesiveness.
- **Do Not Use Chemical Cleansers.**
If the unit gets dirty please wipe with a soft cloth to remove any dirt. Do not use chemical cleansers such as thinner, benzene, or alcohol.
- **Do not install the product in any place subject to high temperature or any place where water may be splashed.**
- **Make sure to replace all screws and parts to their original place.**
- **Do not install the product in a place where it will cause distraction.**
- **Do not, in any manner, process, take apart, or make changes to this product.**

Features

Sensor Connection Models

Wide Range Compatible Sensor Connection Models
*Sensors for display is included

Low Position Holder

New meter gauge holder allows for installation at 5 mm lower than normal.

Illumination

White LED lighting of Dial and Needle.

Warning and Peak reading

Blinks red LED at the set value as Warning and the Peak reading.

Stepping Drive

Our stepping motor is able to provide a smooth, highly precise display.

Part Names and Displays

- 1 Display** Display BOOST data.
- 2 LED** Blinks red LED at the set rpm and the Peak reading.
- 3 Switch** Use to set the warning and display and reset the peak value.
- 4 Needle** Shows the current values and peak value.
- 5 Illumination** Normally illuminated when on display. (dial : white, needle : white)

Size [Unit : mm]

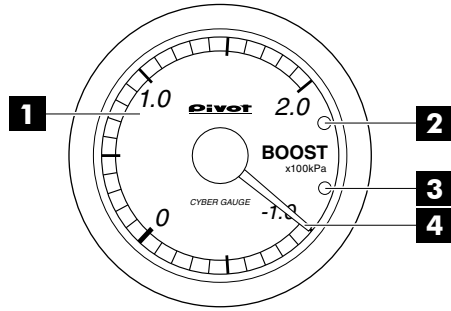
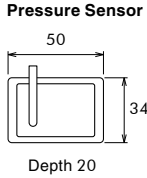
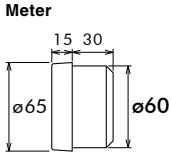

Display Range	Warning	Peak Value
-100 ~ 200kPa	Over the set value	Maximum side

Connecting the Wires

BASIC WIRING

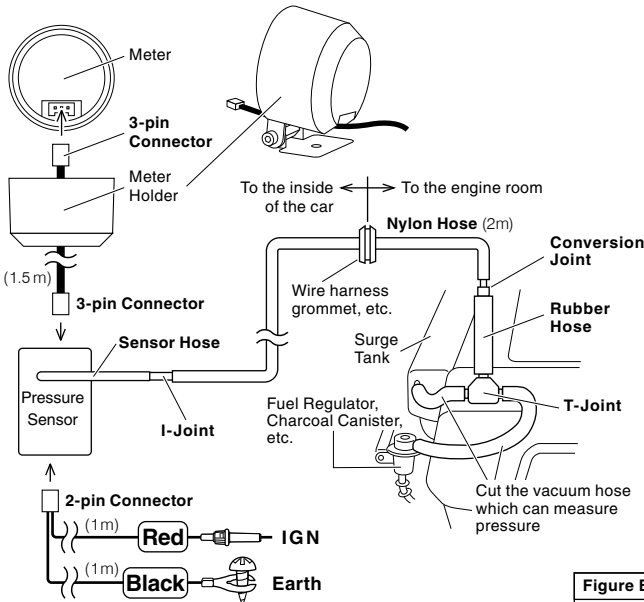

Connecting for Boost

How to connect

- ① Cut the vacuum hose which can measure pressure directly from a surge tank or a intake manifold in the engine room. (e.g., the hose connecting to a fuel regulator, a charcoal canister, etc.)
- ② Insert a T-joint and connect the various hoses and joints as shown in Figure A.
- ③ Pull the nylon hose to the inside of the car through a wire harness grommet, etc.
- ④ Using the I-joint, connect the nylon hose to the unit. (Figure B)



Make sure that all hose and joint connections are securely fastened so as not to disconnect or cause pressure loss. (Depending on the conditions, it may be necessary to take some action to prevent loosening and disconnection of the various connection points.)

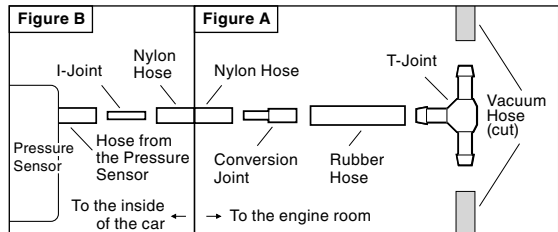

1. Be sure install the unit on the inside of the car. (Not in the engine room)
2. Stretch the hose that comes out from the Pressure Sensor but do not pull it off.
3. If the hose can measure pressure is other than $\phi 4$, please prepare a separately sold joint that matches the size of the hose.



IGN

Red Connect to the IGN (12V with key ON) using the cut connectors (included). (Do not connect to ACC)

Earth

Black with earth terminal Fasten to a screw of a metal part which is earthed.

● Painted screws and screws connected to plastic parts are not earthed; make sure to connect only to a place which is earthed.

[Reference] How to use the Cut Connectors

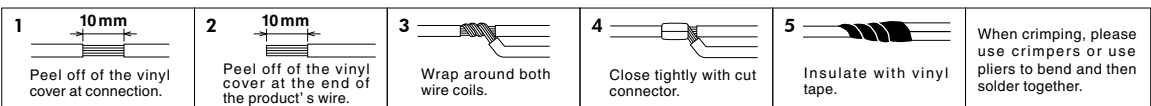

Installing The Product

Installing The Meter (Installation with the Meter Holder)

- ① Fasten using the double-sided tape. (Clean the surface; removing all oil and dust.)

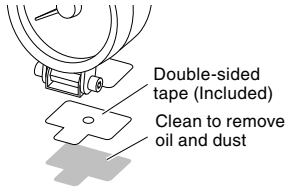

*Please be sure about where you wish to install the meter, as it is not advisable to reuse double-sided tape.

- ② After deciding the position and angle of the meter face, fasten the Hexagonal bolt on both sides to secure.

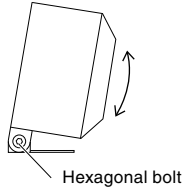

- ③ Affix Cushion tape on 2 to 4 places to the base of the meter and install the gauge into the Meter Holder.

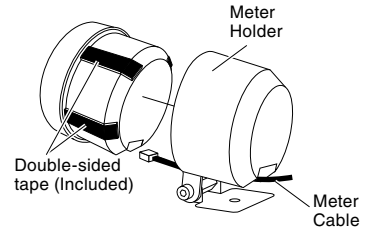

- When using Link Cable, put the connector to the back of Meter Holder as shown in the below diagram. Push the remained cable between the meters to inside of Meter Holder.

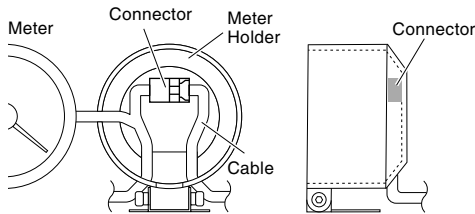

Installing the Sensor

Fastening to Flat Space

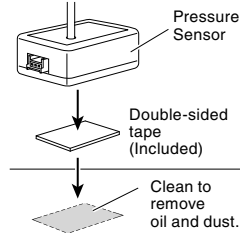

(Example of Installation)

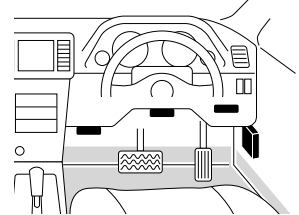

As shown in the above diagram, fasten the unit into positions not usually affected by water.

Basic Operation

- 1 **Key Switch ON** (Engine start)
- 2 **Opening Demo**
- 3 **Real-time display**
- 4 **Key Switch OFF** (Engine stop)
- 5 **Meter OFF** The needle stops when the key is turned OFF.

Opening Demo

- The needle will move to the lowest value side several times for searching position. Then it will move to the maximum value and finally to reading for current measurement item.

Switching The Display and Setting

Peak reading display

- 1 **Press the switch once**
While the meter is in operation, press the switch once.
- 2 **Peak reading display**
LED will light.
- 3 **Real-time display**
Back to real-time display after 3 seconds releasing the switch.



Reset the Peak reading

- 1 **Press the switch for 3 seconds**
Pressing the switch while displaying the peak reading will re-set the peak reading.
- 4 **Reset the Peak reading**
LED will light off.
- 5 **Real-time display**



※Each peak value can be reset by the key OFF.

Setting of Warning

※Can't make setting of Warning while displaying Peak reading(LED lighting).

1   **Press the switch for 3 seconds**
While the meter is in operation, press the switch for 3 seconds.

2 **Setting warning point display**
LED will blink.

3  **Press the switch**  Each pressing of the switch will raise, at the maximum point it will return to the minimum point.
While holding down the switch, change the warning setting.
※By continually pressing down on the switch the needle will move to the maximum point.

4  **Release the switch**

5  **Real-time display**
LED will light off and back to real-time display after 3 seconds releasing the switch.

Troubleshooting

Trouble	Possible Causes	Possible Solutions
Does not work with Engine start.	Poor connection of Gauge Cable , Power Cable .	Please reconfirm whether wiring and connections are correct or not.
The opening demo starts with Engine start, but the needle does not work.	Poor connection of the vacuum hose.	Please reconfirm whether wiring and connections are correct or not.
	Unable to measure pressure.	Please make sure to connect the hose which can measure pressure.
The opening demo starts on different timing with the other Cyber Gauges.	Difference of power cable connection.	Please make sure to connect to the IGN where the other Cyber Gauges connected.
The displayed values are different from the standard meter.	This product's boost meter reads absolute pressure and may differ from a meter using relative pressure.	

※Our products have already been recognized as our Industrial Property or are in the process of receiving Industrial Property status.
 ※We plan in the near future to take all possible legal measures to protect against unfair competition from look-alike products using similar designs, regulating characteristics, circuitry and circuitry layout.
 ※We strictly prohibit the unlicensed use of the PIVOT trademark and the unauthorized use of PIVOT User's Manual.