

# DUAL GAUGE PRO

## Easy Installation

BOOST+DIGITAL

# DPB-E

Designed For Euro car like as BMW-VW

# USER'S MANUAL

Thank you for purchasing this PIVOT product.  
Please read this manual carefully and keep it for future reference.

- If this product is given to another user, make sure to include this User's Manual.

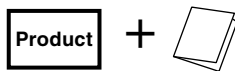

## Contents

Contents / WARNING / CAUTION ..... 1  
 Features ..... 1  
 Part Names and Displays ..... 1  
 Connecting The Wires ..... 2  
 Installing The Product ..... 2~3  
 (Connecting The Wires by Using Sensor) ..... 3  
 Basic Operation ..... 4  
 Switching The Display ..... 4  
 Illumination color settings ..... 4  
 Illumination brightness settings ..... 4  
 Troubleshooting ..... 4

## Please check the contents of the package

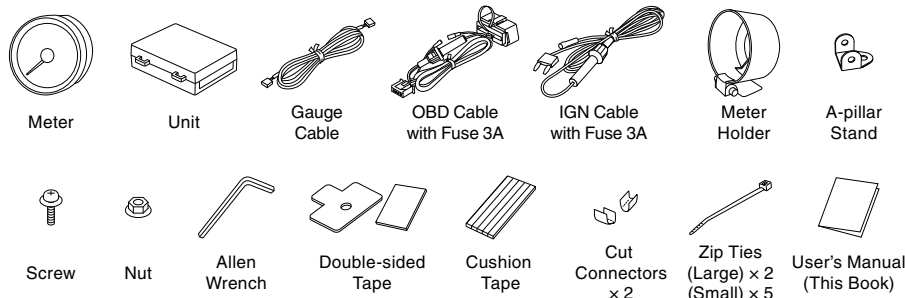

1. The display will not be proper if the ECU being used is not the standard one or if a sub-computer is being used, even in compatible car models. (except connecting with sensor)
2. When installing PIVOT Sub Computer(POWER DRIVE), need to use separately sold Boost Sensor(DP-BS) to display Boost data.
3. Cannot be used in combination with other company's products that use Diagnostic Monitoring Connectors.
4. For details about using combinations of PIVOT OBD products, see here. ⇒ <https://pivotjp.com/obd-e/>

### WARNING Improper use or disregard of these warnings may result in the injury or death of people.

- **Do not work in areas where there is excessive exhaust.**  
Due to vehicle exhaust emission poisoning or fire may result in a damage to humans.
- **Do not crush the cable.**  
Please be careful that the cable does not get crushed by the seat rail or car door steel plate, nor cut by any sharp steel plate as this may cause a poor connection or an electric short leading to fire or other danger.
- **Do not operate while driving.**  
Operating or checking the display during driving may cause an accident; please use with the utmost consideration for safety.
- **Please securely fasten the product to a stable place and be sure to store bundle away all wires with tape, etc...**  
It is very dangerous to pull tangled wires by force or allow tangled wires to interfere with driving.

### CAUTION Improper use or disregard of these warnings may cause injury to persons, damage the product and other things.

- **This product is for DC12V cars;**  
Installation cannot be carried out on cars with other voltage batteries.
- **Just after installation do not exert any strong force on the product.**  
When double-sided tape is used for an installation be warned that when hot the tape temporarily loses adhesiveness.
- **Do Not Use Chemical Cleansers.**  
If the unit gets dirty please wipe with a soft cloth to remove any dirt. Do not use chemical cleansers such as thinner, benzene, or alcohol.
- **Do not install the product in any place subject to high temperature or any place where water may be splashed.**
- **Make sure to replace all screws and parts to their original place.**
- **Do not install the product in a place where it will cause distraction.**
- **Do not, in any manner, process, take apart, or make changes to this product.**

## Features

Adoption of start detector circuitry makes installing easier with OBD connection and compatible with a wide variety of model cars by the specialized Euro-model communication. The illumination can switch between white and BMW-style orange.

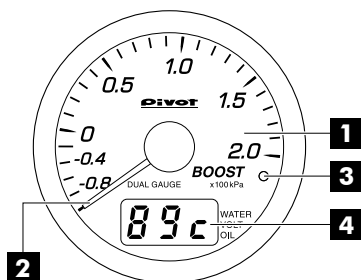

- BMW and some models of MINI display around -15 to -20 kPa when reading negative pressure.

## Part Names and Displays

<b>1 Analog Display</b> Display Boost data.	<b>5 Illumination (night illumination)</b> Normally illuminated when on display and Three-step dimming.
<b>2 Needle</b> Shows the current values and peak value.	<b>Analog Display</b> Dial and Needle: White or Orange (switchable)
<b>3 Switch</b> Use to change modes of digital display and reset the peak value.	<b>Digital Display</b> Red
<b>4 Digital Display</b> Display switches between types.	<b>6 Display Range</b>
	<b>Analog Display</b> Boost [-100 ~ 154 kPa] (OBD data) Boost*[-100 ~ 200 kPa] (Sensor data)
	<b>Digital Display</b> Water Temp [-35 ~ 150 °C] Voltage [8 ~ 18V] Oil Temp*[-35 ~ 150 °C]

\* Displayed with Sensor sold separately.

## [ Unit ]

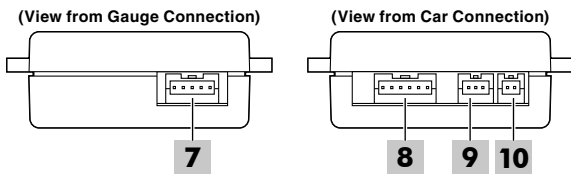

- 7 Meter connector**  
Connect gauge cable
- 8 Power connector**  
Connect OBD cable
- 9 Boost connector**  
Connect Boost sensor (sold separately)
- 10 Oil Temp connector**  
Connect Oil Temp sensor (sold separately)

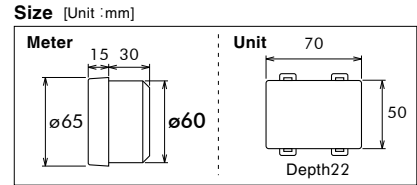

## Connecting The Wires

- ① Engine Start.
- ② Insert the OBD Connector to the Diagnostic Monitoring Connector.
- ③ Insert the 4-pin Connector to the backside of the meter.
- ④ Insert the 5-pin Connector of Gauge Cable and 6-pin Connector from the Power Cable to the Unit.

⚠ If the meter not activate from individual differences in car models or some reasons after the engine starts, you need to change the power source and connect the power cable to IGN.  
⇒ See Separate sheet [Connect the power cable to IGN].

### Placement Diagram for Diagnostic Monitoring Connector

- ① By the accelerator pedal
- ② At the right foot of the driver seat (with lid)

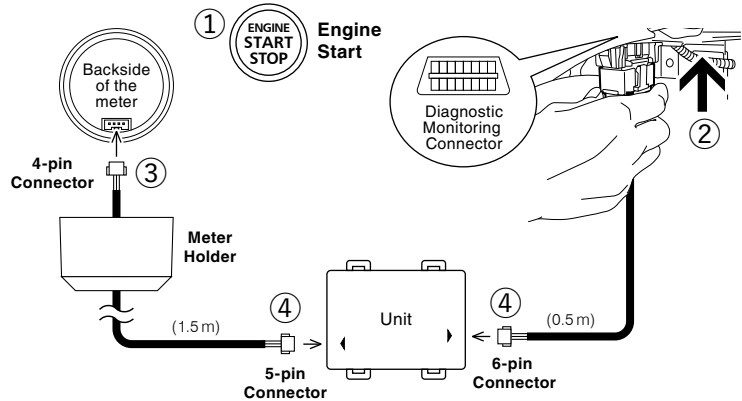
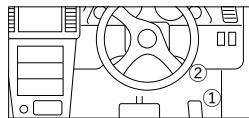

### Notes about using the OBD Connector

Make sure to grip the distended portions when pulling it out or inserting it.

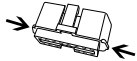

### CAUTION

Do not pull on the wires when trying to remove the connector; the wires may become disconnected.

### If you unable to get a grip on the distended portions.

With some car models it may be difficult to get a good grip on the connector.

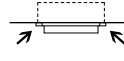

In such case, pull out the connector by pulling on the end of the zip tie.

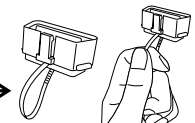

## Installing The Product

### Installing The Meter

#### A Installation with the Meter Holder

- ① Fasten using the double-sided tape.

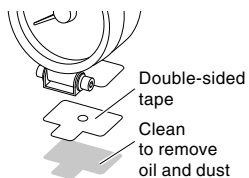

Note : Please be sure about where you wish to install the meter, as it is not advisable to reuse double-sided tape.

- ② After deciding the position and angle of the meter face, fasten the Hexagonal bolt on both sides to secure.

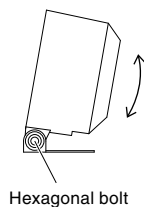

- ③ Affix the Cushion Tape to the base of the meter, connect the Gauge Cable to the Meter, and install the Meter into the Meter Holder. **Please add the Cushion Tape if the Meter not fixed.**

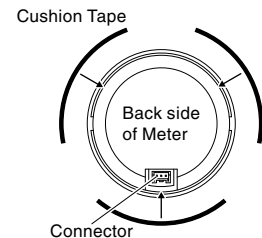
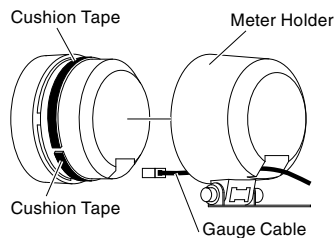

#### B Installation to panel or something

Cut the Cushion Tape in half, affix to base of the Meter to be on press fit condition with adjusting number. And connect the Gauge Cable to the Meter and insert into the panel.

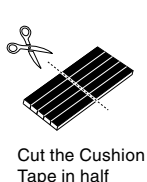

Cut the Cushion Tape in half

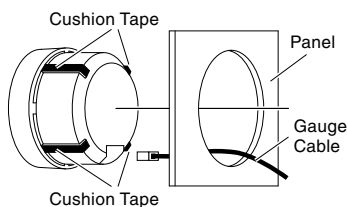

#### C Installation to A-pillar using A-pillar Stand

Make a  $\phi 5$  hole on the place to install the meter of the A-pillar, and fix the Meter using A-pillar Stand with Screw and Nut.

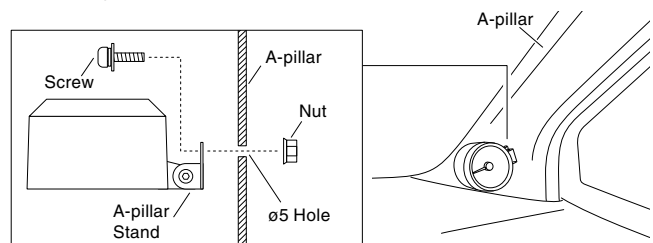

## Installing The Unit

As shown in the below diagram, fasten the unit into positions not usually affected by water.

(Example of Installation)

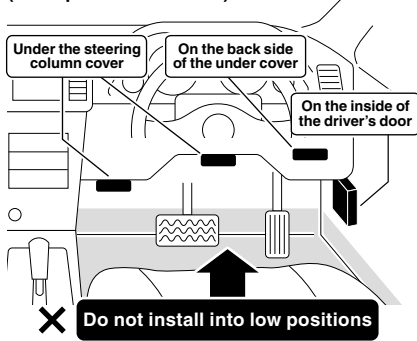

### Fastening to Flat Space

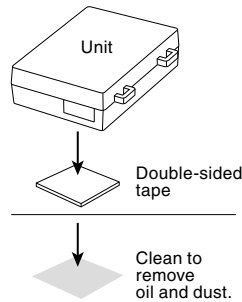

### When Fastenings to a Cable or Pipe

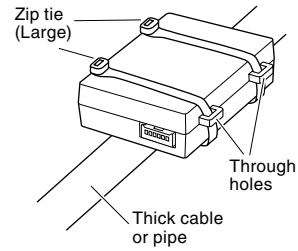

## Connecting The Wires by Using Sensor (Not normally required)

Reading the part of data from sensor connection.

To display Oil Temperature and Boost data from pressure sensor, you need to purchase separately sold sensor and connect as diagram.

### Temperature sensor (DTS)

Surrounded by dashed line are the contents of separately sold Temperature Sensor (DTS).

Depending on the installation you may need a sensor adaptor. (sensor connector 1/8 PT sold separately)

### Boost Sensor (DP-BS)

Surrounded by dotted line are the contents of separately sold Boost Sensor (DP-BS).

For installation of Boost Sensor, you need a marketed sensor adaptor specialized for each car model.

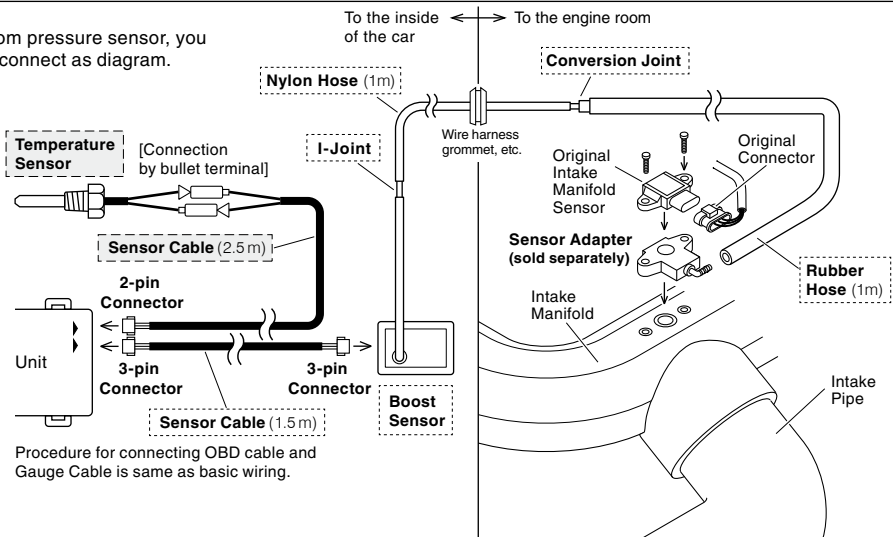

Procedure for connecting OBD cable and Gauge Cable is same as basic wiring.

## Connecting Sensor

### Temperature Sensor

#### Oil Drain Hole Installation

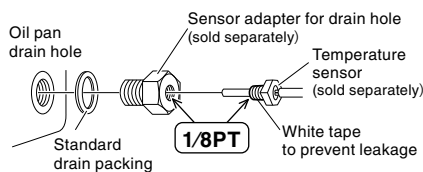

In case of the sensor protruding in a downward direction, take measures such as changing the position of the sensor.

### Boost Sensor

#### Connecting for Boost

1. Cut the vacuum hose which can measure pressure directly from a surge tank or a intake manifold in the engine room. (e.g., the hose connecting to a fuel regulator, a charcoal canister, etc.)
2. Insert a T-joint and connect the various hoses and joints as shown in Figure A.
3. Pull the nylon hose to the inside of the car through a wire harness grommet, etc.
4. Using the I-joint, connect the nylon hose to the unit. (Figure B)

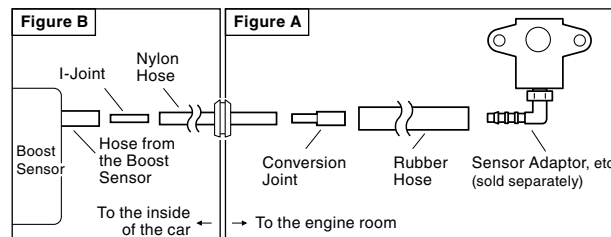

Make sure that all hose and joint connections are securely fastened so as not to disconnect or cause pressure loss. (Depending on the conditions, it may be necessary to take some action to prevent loosening and disconnection of the various connection points.)

1. Be sure install the Boost Sensor on the inside of the car. (Not in the engine room)
2. Stretch the hose that comes out from the Boost Sensor but do not pull it off.
3. If the hose can measure pressure is other than  $\phi 4$ , please prepare a separately sold joint that matches the size of the hose.

# Basic Operation

- 1 **Engine Start**
  - 2 **Opening Demo**
  - 3 **Display Each Mode**
  - 4 **Engine Stop**
  - 5 **Meter OFF**
- The needle stops in the vicinity of lowest value.

**Opening Demo**

- When the engine starts, the needle will move to the extreme left several times for searching position. Then it will move to the maximum value and finally to reading for current measurement item.
- Due to analysis time for the car data transmission it may take up to a few seconds from engine start before opening demo.(except wiring IGN)

**Turning off the Display**

- Due to analysis time for the car data transmission, the illumination may remain on for up to 1 minutes even after the engine has been turned off; this is normal and no effect on the vehicle performance. (except wiring IGN)

## Switching The Display

### Switching The Digital Display

Press switch to change the multi-digital display in operation

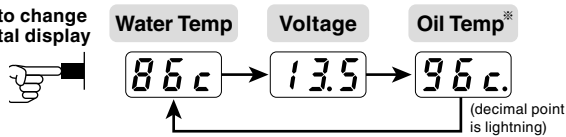

### Water Temperature / Oil Temperature\* Reading the Display

[ -35 ~ -1 °C ] The first place on the below shows "-" (minus). - 00	[ 0 ~ 99 °C ] The third place from the below shows "C" (Celsius). 00 C	[ 100 ~ 150 °C ] Numerical Value Only. 100
--	--	--

\*Not displayed without temperature sensor.

### Display and Reset the Peak Value

#### Real-time Display

#### Peak Value Display

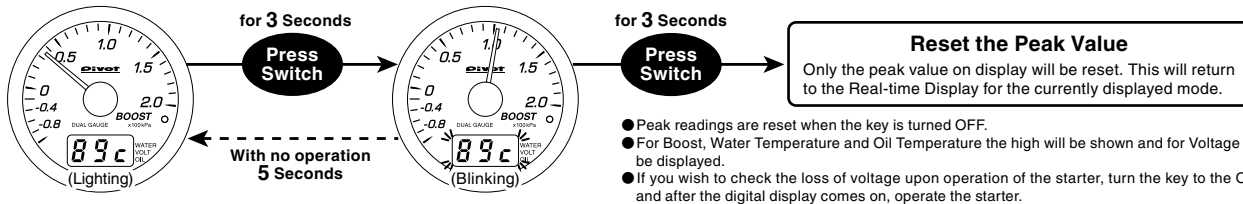

- Peak readings are reset when the key is turned OFF.
- For Boost, Water Temperature and Oil Temperature the high will be shown and for Voltage the low will be displayed.
- If you wish to check the loss of voltage upon operation of the starter, turn the key to the ON position and after the digital display comes on, operate the starter.

## Illumination color settings

- 1 **Engine Start**  
After the meter off, Engine start during pressing the switch
- 2 **Display the current illumination color setting**  
c - 1 (e.g. c - 1)  
Release the switch after displayed the current setting
- 3 **Press the switch to change the color**  
c - 1 ↔ c - 2  
[ c - 1 = White, c - 2 = Orange ]  
Each pressing will change the color.
- 4 **Release the switch after setting is done**
- 5 **Back to normal display with no operation for 5 seconds**  
**Setting Completed**

## Illumination brightness settings

Adjustment in case of anxious about reflected illumination of door mirror or something

- 1 **Press the switch for 6 seconds**  
Holding down the switch in operation
- 2 **Display a peak value after 3 seconds and the current brightness after 6 seconds**  
L - 3 (e.g. L - 3)
- 3 **Release the switch after displayed the current setting**
- 4 **Press the switch to change the brightness**  
L - 3 → L - 2 → L - 1  
(High) (Mid) (Low)  
Each pressing will change the brightness
- 5 **Release the switch after setting is done**
- 6 **Back to normal display with no operation for 5 seconds**  
**Setting Completed**

## Troubleshooting

Trouble	Possible Causes	Possible Solutions
Does not work with Engine start.	Poor connection of <b>Gauge cable</b> , <b>6-pin Connector</b> or <b>OBD Connector</b> wires. The unit has been installed into an incompatible car model.	Please reconfirm whether wiring and connections are correct or not. Please reconfirm the Fitting List.
Upon starting up, the unit will not start in the newly changed display.	Because after changing displays, if the car's engine is turned off within 3 seconds, the new setting will not be stored, make sure to wait at least 3 seconds before turning the engine off.	
Before the opening demo starts the needle briefly moves.	This is due to a special characteristic of the meter and is not a malfunction.	
The displayed values are different from the standard meter.	Due to the ECU information received, the displayed values on this product may differ from those of standard or other meters.	

\*Our products have already been recognized as our Industrial Property or are in the process of receiving Industrial Property status.

\*We plan in the near future to take all possible legal measures to protect against unfair competition from look-alike products using similar designs, regulating characteristics, circuitry and circuitry layout.

\*We strictly prohibit the unlicensed use of the PIVOT trademark and the unauthorized use of PIVOT User's Manual.

## Connect the power cable to IGN

Use the supplied IGN Cable to get power from IGN.

IGN Cable (2.7m)

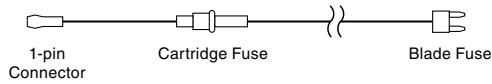

The meter start-up and stop is differ in power connection method.

Normal (not using IGN Cable)	IGN (using IGN Cable)
Linked to the ECU	Linked to the key switch

### Connect IGN Cable

#### A In case of BMW 3series, etc.

- ① Unplug the connector of **Yellow** and **Red** cable of OBD Cable.
- ② Connect **Yellow** cable of OBD Cable to 1-pin Connector of IGN Cable.
- ③ Connect to Blade Fuse of IGN Cable into IGN of the Fuse box.

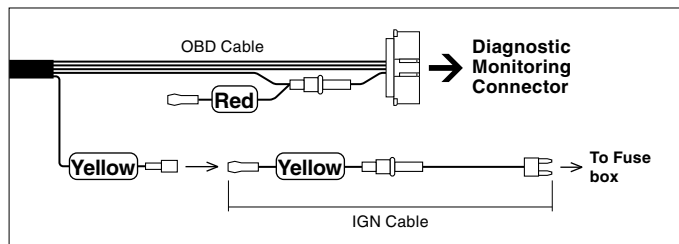

#### B Using commercially available Fuse power supply

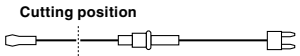
- ① Cut the IGN Cable on the position of the below and connect to the commercially available Fuse power supply.
- 
- ② Unplug the connector of **Yellow** and **Red** cable of OBD Cable.
  - ③ Connect **Yellow** cable of OBD Cable to 1-pin Connector of IGN Cable.
  - ④ Connect to Blade Fuse of IGN Cable into IGN of the Fuse box in the engine room.

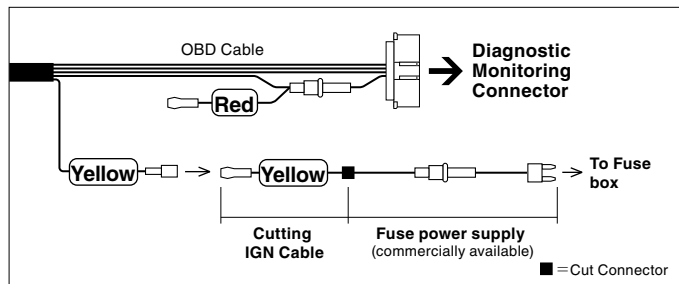

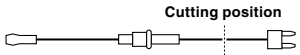

#### C Directly connect to IGN of the vehicle

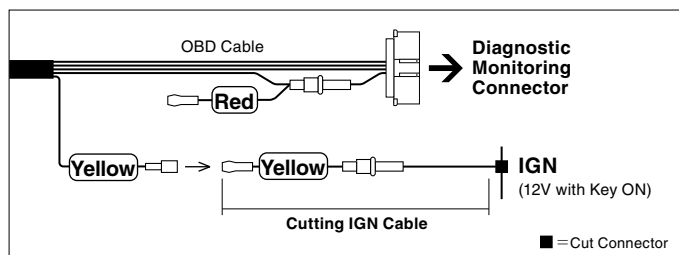
- ① Cut the IGN on the position of the below and connect to the commercially available Fuse power supply by using bullet terminal.
- 
- ② Unplug the connector of **Yellow** and **Red** cable of OBD Cable.
  - ③ Connect **Yellow** cable of OBD Cable to 1-pin Connector of IGN Cable.

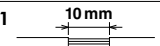
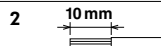
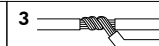
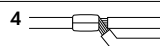

#### How to use the Cut Connectors

<p><b>1</b></p>  <p>Peel off of the vinyl cover at connection.</p>	<p><b>2</b></p>  <p>Peel off of the vinyl cover at the end of the product's wire.</p>	<p><b>3</b></p>  <p>Wrap around both wire coils.</p>	<p><b>4</b></p>  <p>Close tightly with cut connector.</p>	<p><b>5</b></p>  <p>Insulate with vinyl tape.</p>	<p>When crimping, please use crimpers or use pliers to bend and then solder together.</p>
---	--	---	--	--	---