

DUAL GAUGE PRO

Easy Installation

RPM / MOTOR RPM+ DIGITAL

DPT-H

For HYBRID Cars (TOYOTA/HONDA)

USER'S MANUAL

Thank you for purchasing this PIVOT product.
Please read this manual carefully and keep it for future reference.

If this product is given to another user, make sure to include this User's Manual.

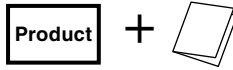

Contents

Contents / WARNING / CAUTION	1
Features	1
Part Names and Displays	2
Connecting The Wires	2
Installing The Product	3
Basic Operation	3
Switching The Display	4
Illumination color settings	4
Illumination brightness settings	4
Troubleshooting	4

Please check the contents of the package

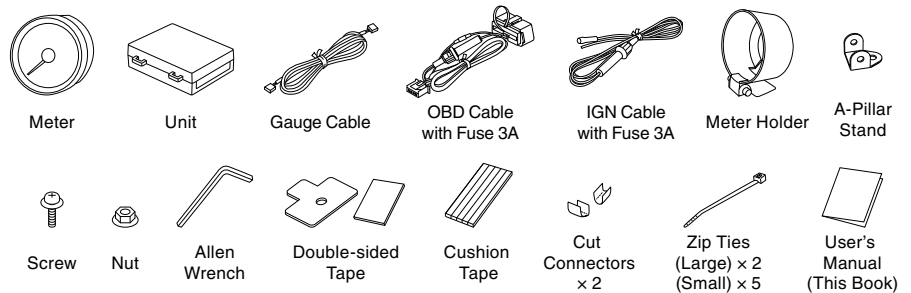

1. The display will not be proper if the ECU being used is not the standard one or if a sub-computer is being used, even in compatible car models.
2. Cannot be used in combination with other company's products that use Diagnostic Monitoring Connectors.
3. For details about using combinations of PIVOT OBD2 products, see here. ⇒ <https://pivotjp.com/obd-e/>

WARNING Improper use or disregard of these warnings may result in the injury or death of people.

- **Do not work in areas where there is excessive exhaust.**
Due to vehicle exhaust emission poisoning or fire may result in a damage to humans.
- **Do not crush the cable.**
Please be careful that the cable does not get crushed by the seat rail or car door steel plate, nor cut by any sharp steel plate as this may cause a poor connection or an electric short leading to fire or other danger.
- **Do not operate while driving.**
Operating or checking the display during driving may cause an accident; please use with the utmost consideration for safety.
- **Please securely fasten the product to a stable place and be sure to store bundle away all wires with tape, etc...**
It is very dangerous to pull tangled wires by force or allow tangled wires to interfere with driving.

CAUTION Improper use or disregard of these warnings may cause injury to persons, damage the product and other things.

- **This product is for DC12V cars;**
Installation cannot be carried out on cars with other voltage batteries.
- **Just after installation do not exert any strong force on the product.**
When double-sided tape is used for an installation be warned that when hot the tape temporarily loses adhesiveness.
- **Do Not Use Chemical Cleansers.**
If the unit gets dirty please wipe with a soft cloth to remove any dirt. Do not use chemical cleansers such as thinner, benzene, or alcohol.
- **Do not install the product in any place subject to high temperature or any place where water may be splashed.**
- **Make sure to replace all screws and parts to their original place.**
- **Do not install the product in a place where it will cause distraction.**
- **Do not, in any manner, process, take apart, or make changes to this product.**

Features

The world's first meter designed for hybrid cars for easy viewing of both engine and motor rpm. (Patent pending)

Easy Installation

Simple coupler connection to Diagnostic monitor connector.

Dual Display

Indicator needle and digital display provide easy viewing of multi-data.

Black Titanium Bezel

High quality black titanium bezel.

2-Color Illumination Switch with 3-step Dimmer

Illumination switch allows selection between two colors and brightness adjusted with three-step dimmer.

Meter Holder included

The included full cover type holder allows seamless installation to a number of places.

Peak Hold

Save and display each peak reading after engine starts.

Additional Sensor

If the use of a sub computer makes getting correct readings impossible or if data cannot be received via OBD, we offer additional separately sold sensors.

Part Names and Displays

[Meter]

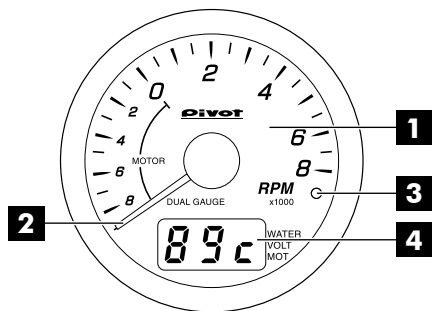

Note: Not display Motor RPM on Analog Display when the Meter displays RPM by needle. See the Digital Display to check the Motor RPM.

- 1 Analog Display**
- 2 Needle**
- 3 Switch**
- 4 Digital Display**
- 5 Illumination (night illumination)**

Display RPM and Motor RPM data. (See Note)

Shows the current values and peak value.

Use to change modes of digital display and reset the peak value.

Display switches between types.

Normally illuminated when on display and Three-step dimming.

Analog Display	Dial & Needle : White or Blue (Switchable)
Digital Display	Red
Analog Display	RPM [0-8000rpm] Motor RPM [0-9000rpm]
Digital Display	Water Temp [-35-150 °C] Voltage [8-18 V] Motor RPM [0-32000rpm]

Size [Unit : mm]

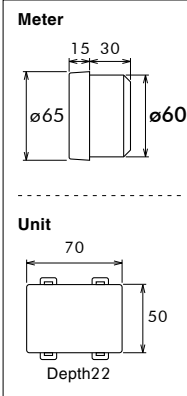

[Unit]

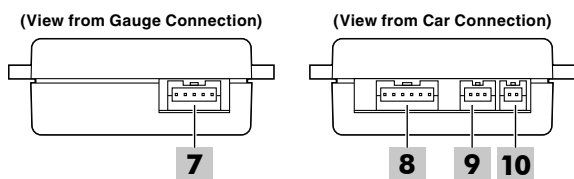

- 7 Meter connector** Connect gauge cable
- 8 Power connector** Connect OBD cable
- 9 10 Spare** No need to use

Connecting The Wires

- 1 Turn the power switch to Ready Mode.
- 2 Insert the OBD Connector to the Diagnostic Monitoring Connector.
- 3 Insert the 4-pin Connector to the backside of the meter.
- 4 Insert the 5-pin Connector of Gauge Cable and 6-pin Connector from the Power Cable to the Unit.

Placement Diagram for Diagnostic Monitoring Connector

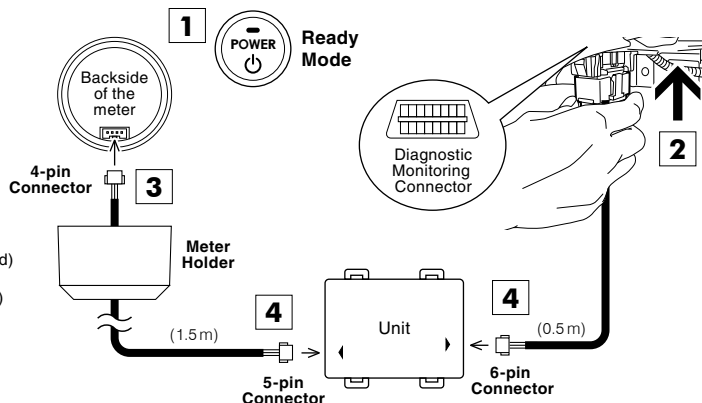
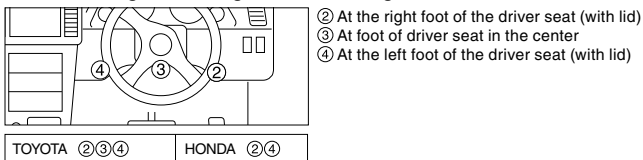

If connect the power cable to IGN

(The installing car model mentioned in the Compatibility list or the display does not lit with engine start sometimes.)

The meter start-up and stop is differ in power connection method.

Normal (not using IGN Cable)	IGN (using IGN Cable)
Linked to the ECU	Linked to the power switch

Unplug the connector of **Yellow** and **Red** cable of OBD Cable and connect **Yellow** cable of IGN Cable into the connector on **Yellow** cable, then connect to IGN cable to IGN of car. (Do not connect to Acc)

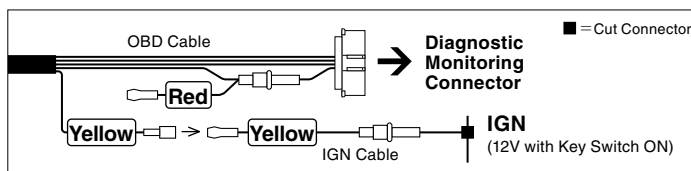

Notes about using the OBD Connector

Make sure to grip the distended portions when pulling it out or inserting it.

CAUTION

Do not pull on the wires when trying to remove the connector; the wires may become disconnected.

If you unable to get a grip on the distended portions.

With some car models it may be difficult to get a good grip on the connector.

In such case, pull out the connector by pulling on the end of the zip tie.

How to use the Cut Connectors

<p>1 10mm</p> <p>Peel off of the vinyl cover at connection.</p>	<p>2 10mm</p> <p>Peel off of the vinyl cover at the end of the product's wire.</p>	<p>3</p> <p>Wrap around both wire coils.</p>	<p>4</p> <p>Close tightly with cut connector.</p>	<p>5</p> <p>Insulate with vinyl tape.</p>	<p>When crimping, please use crimpers or use pliers to bend and then solder together.</p>
---	--	--	---	---	---

Installing The Product

Installing The Meter

A Installation with the Meter Holder

1. Fasten using the double-sided tape.

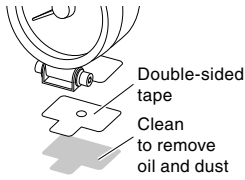

Note : Please be sure about where you wish to install the meter, as it is not advisable to reuse double-sided tape.

2. After deciding the position and angle of the meter face, fasten the Hexagonal bolt on both sides to secure.

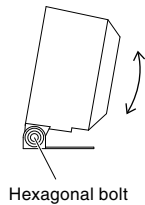

3. Affix the Cushion Tape to the base of the meter, connect the Gauge Cable to the Meter, and install the Meter into the Meter Holder. **Please add the Cushion Tape if the Meter not fixed.**

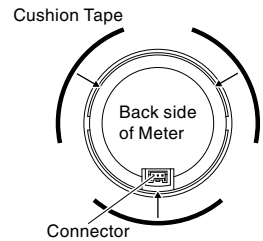
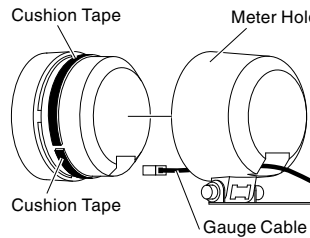

B Installation to panel or something

Cut the Cushion Tape in half, affix to base of the Meter to be on press fit condition with adjusting number. And connect the Gauge Cable to the Meter and insert into the panel.

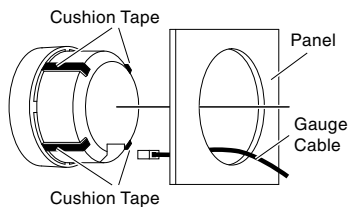
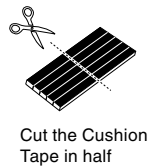

C Installation to A-pillar using A-pillar Stand

Make a $\phi 5$ hole on the place to install the meter of the A-pillar, and fix the Meter using A-pillar Stand with Screw and Nut.

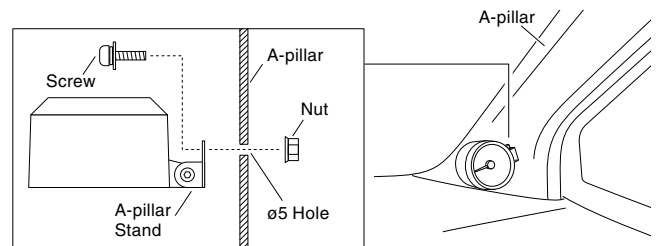

Installing The Unit

As shown in the below diagram, fasten the unit into positions not usually affected by water.

(Example of Installation)

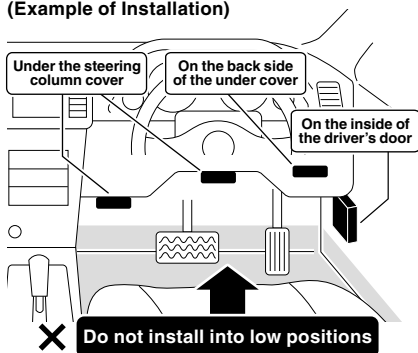

Fastening to Flat Space

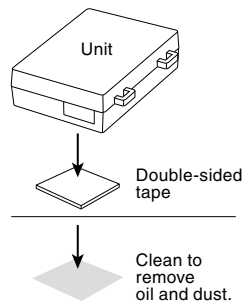

When Fastenings to a Cable or Pipe

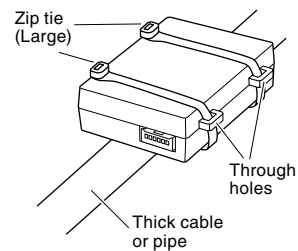

Basic Operation

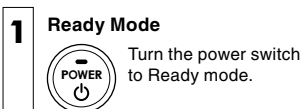

Opening Demo • When in Ready Mode the needle will move to the extreme left several times for searching position. Then it will move to the maximum value and finally to reading for current measurement item.

• Due to analyzation time for the car data transmission it may take up to a few seconds from engine start before opening demo. (except wiring IGN)

Switching The Display

Switching The Digital Display

Press switch to change the multi-digital display in operation

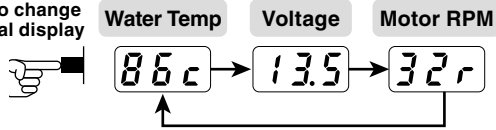

Water Temperature Reading the Display

-35--1 °C The first place on the left shows "-" (minus).	0-99 °C The third place from the left shows "C" (Celsius).	100-150 °C Numerical Value Only.
- 00	00 C	100

Motor RPM Reading the Display (display unit : 100rpm)

0-9900rpm	over 10000rpm
00 r	000 (decimal point is lightning)

Display and Reset the Peak Value

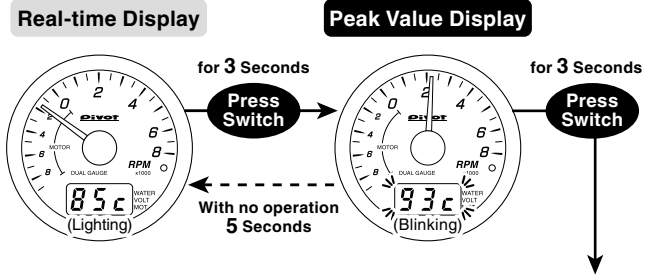

Reset the Peak Value
Only the peak value on display will be reset. This will return to the Real-time Display for the currently displayed mode.

- Peak readings are reset when the power is turned OFF.
- For RPM and Water Temperature the high will be shown and for Voltage the low will be displayed.
- For Motor RPM the high Peak Value will be shown on the Digital Display.

Illumination color settings

1. Press the switch to enter READY Mode. After the meter off, Engine start during pressing the switch.
2. Display the current illumination color setting (Initial value: c-1). Release the switch after displayed the current setting.
3. Press the switch to change the color. [c-1 = White, c-2 = Blue]. Each pressing will change the color.
4. Release the switch after setting is done.
5. Back to normal display with no operation for 5 seconds. Setting Completed.

Illumination brightness settings

Adjustment in case of anxious about reflected illumination of door mirror or something

1. Press the switch for 6 seconds. Holding down the switch in operation.
2. Display a peak value after 3 seconds and the current brightness after 6 seconds (Initial value: L-3).
3. Release the switch after displayed the current setting.
4. Press the switch to change the brightness. Each pressing will change the brightness (High, Mid, Low).
5. Release the switch after setting is done.
6. Back to normal display with no operation for 5 seconds. Setting Completed.

Troubleshooting

Trouble	Possible Causes	Possible Solutions
Does not work with Engine start.	Poor connection of Gauge cable, 6-pin Connector or OBD Connector wires. The unit has been installed into an incompatible car model.	Please reconfirm whether wiring and connections are correct or not. Please reconfirm the Fitting List.
Upon starting up, the unit will not start in the newly changed display.	Because after changing displays, if the car's engine is turned off within 3 seconds, the new setting will not be stored, make sure to wait at least 3 seconds before turning the engine off.	
Before the opening demo starts the needle briefly moves.	This is due to a special characteristic of the meter and is not a malfunction.	
The displayed values are different from the standard meter.	Due to the ECU information received, the displayed values on this product may differ from those of standard or other meters.	

(Note) • Our products have already been recognized as our Industrial Property or are in the process of receiving Industrial Property status.
• We plan in the near future to take all possible legal measures to protect against unfair competition from look-alike products using similar designs, regulating characteristics, circuitry and circuitry layout.
• We strictly prohibit the unlicensed use of the PIVOT trademark and the unauthorized use of PIVOT User's Manual.