

One Type Analog Display coupled with Multi-Digital Display.

USER'S MANUAL (Product Number: DSB)

DUAL GAUGE

Sensor Connection

BOOST+DIGITAL **DSB**

Thank you for purchasing this PIVOT product.
Please read this manual carefully and keep it for future reference.

- If this product is given to another user, make sure to include this User's Manual.

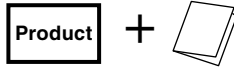

Contents

Contents / WARNING / CAUTION 1
 Features 2
 Part Names and Displays 2
 Connecting The Wires 2~3
 Installing The Product 3
 Basic Operation 4
 Switching The Display 4
 Troubleshooting 4

Please check the contents of the package

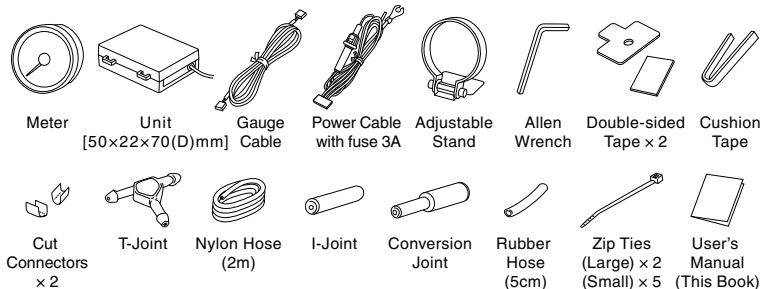

⚠ WARNING

Improper use or disregard of these warnings may result in the injury or death of people.

- **Do not work in areas where there is excessive exhaust.**

Due to vehicle exhaust emission poisoning or fire may result in a damage to humans.

- **Do not crush the cable.**

Please be careful that the cable does not get crushed by the seat rail or car door steel plate, nor cut by any sharp steel plate as this may cause a poor connection or an electric short leading to fire or other danger.

- **Do not operate while driving.**

Operating or checking the display during driving may cause an accident; please use with the utmost consideration for safety.

- **Please securely fasten the product and be sure to store bundle away all wires with tape, etc...**

It is very dangerous to pull tangled wires by force or allow tangled wires to interfere with driving.

⚠ CAUTION

Improper use or disregard of these warnings may cause injury to persons, damage the product and other things.

- **This product is for DC12V cars;**

Installation cannot be carried out on cars with other voltage batteries.

- **Just after installation do not exert any strong force on the product.**

When double-sided tape is used for an installation be warned that when hot the tape temporarily loses adhesiveness.

- **Do Not Use Chemical Cleansers.**

If the unit gets dirty please wipe with a soft cloth to remove any dirt. Do not use chemical cleansers such as thinner, benzene, or alcohol.

- **Do not install the product in any place subject to high temperature or any place where water may be splashed.**

- **Make sure to replace all screws and parts to their original place.**

- **Do not install the product in a place where it will cause distraction.**

- **Do not, in any manner, process, take apart, or make changes to this product.**

Features

Each of our Dual Gauges offer one type of analog display coupled with a multi-digital display in one smart looking unit, thus saving not only space but money.

Wide Range Compatible Sensor Connection Models

Like most gauges, the DS Series models are installed by wiring to the appropriate sensor; this means greater compatibility with a wide range of car models.

Part Names and Displays

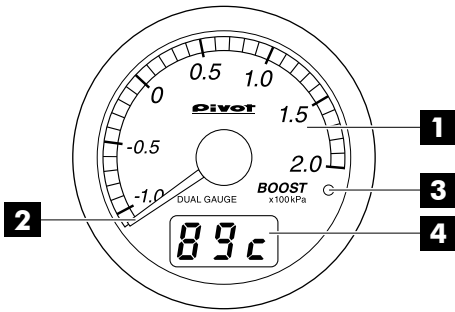

- 1 Analog Display** Display BOOST data.
- 2 Needle** Shows the current values and peak value.
- 3 Switch** Use to change modes of digital display and reset the peak value.
- 4 Digital Display** Display switches between types.
- 5 Illumination (night illumination)** Normally illuminated when on display.
- 6 Display Range**

| | |
|------------------------|--|
| Analog Display | Dial : White, Needle : Red |
| Digital Display | Red |
| Analog Display | BOOST [-100 ~ 200kPa] |
| Digital Display | Voltage [8 ~ 18V] |
| | Water temp / Oil Temp [-35 ~ 150°C] (Displayed with Sensor sold separately) |

Connecting the Wires

BASIC WIRING

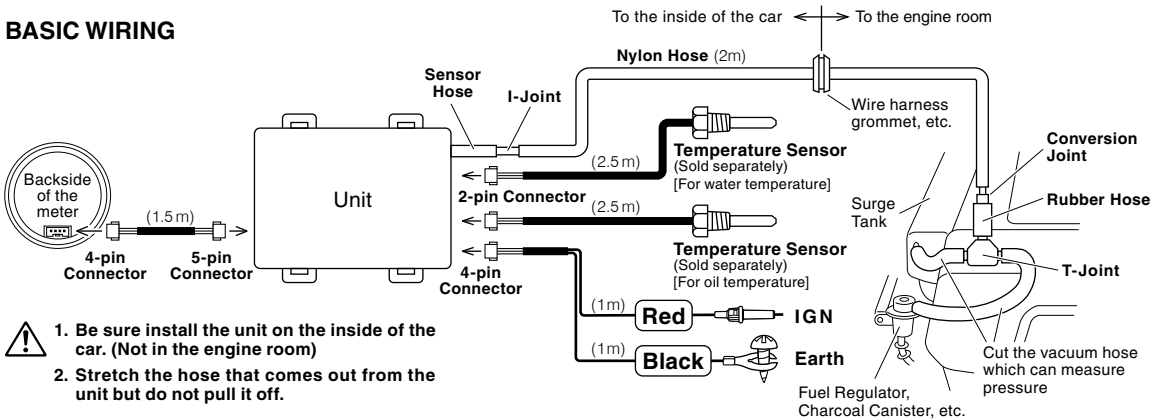

1. Be sure install the unit on the inside of the car. (Not in the engine room)
2. Stretch the hose that comes out from the unit but do not pull it off.

Connecting for Boost

How to connect

- 1 Cut the vacuum hose which can measure pressure directly from a surge tank or a intake manifold in the engine room. (e.g., the hose connecting to a fuel regulator, a charcoal canister, etc.)
- 2 Insert a T-joint and connect the various hoses and joints as shown in Figure A.
- 3 Pull the nylon hose to the inside of the car through a wire harness grommet, etc.
- 4 Using the I-joint, connect the nylon hose to the unit. (Figure B)

- !** Make sure that all hose and joint connections are securely fastened so as not to disconnect or cause pressure loss. (Depending on the conditions, it may be necessary to take some action to prevent loosening and disconnection of the various connection points.)

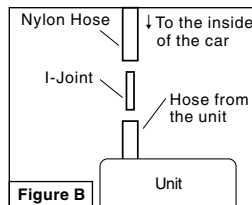
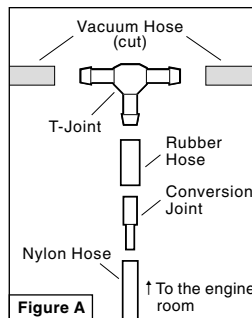

IGN

Red Connect to the IGN (12V with key ON) using the cut connectors (included).

Earth

Black with earth terminal Fasten to a screw of a metal part which is earthed.

- Painted screws and screws connected to plastic parts are not earthed; make sure to connect only to a place which is earthed.

[Reference] How to use the Cut Connectors

| | |
|---|---|
| 1 10 mm Peel off of the vinyl cover at connection. | 2 10 mm Peel off of the vinyl cover at the end of the product's wire. |
| 3 Wrap around both wire coils. | 4 Close tightly with cut connector. |
| 5 Insulate with vinyl tape. | *When crimping, please use crimpers or use pliers to bend and then solder together. |

Connecting Sensor

To display Water temperature and Oil temperature, you must purchase Temperature sensor (DTS ¥3,800) which is sold separately.

⚠ Depending on the installation you may need a sensor adaptor. (sensor connector 1/8 PT sold separately)

Connecting Water Sensor

Use the hose joint (sold separately) to attach the temperature sensor to the upper hose of radiator.

- ① Cut the upper radiator hose at a suitable spot. (Water coolant will spill out, so prepare replacement coolant.)
- ② Fit the hose band onto the cut upper hose and securely connect the cut hose to the hose joint with the hose band, so as no leakage will occur.

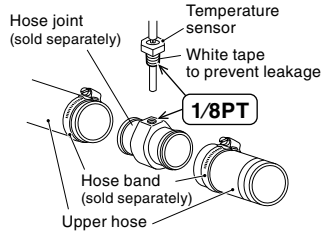
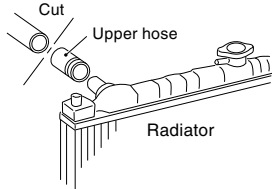

Connecting Oil Sensor

Oil Drain Hole Installation

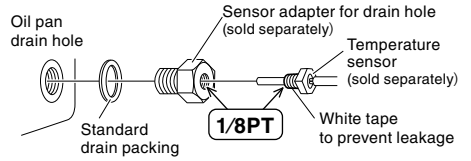

WARNING For cars chassis that are low to the ground or in cases where road conditions may be poor, please do not use this type of installation. It may lead the sensor to bump against the ground and break or be damaged.

Oil Element Installation

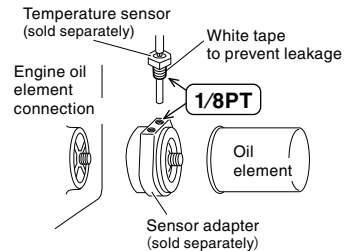

Installing The Product

Installation with the Adjustable Stand

Fasten using the double-sided tape. (On top of the steering column cover or dashboard.)

- ① Slightly loosen the Hexagonal bolt and install the gauge into the Adjustable Stand.
 - ② Fasten using the double-sided tape. (Clean the surface; removing all oil and dust.)
 - ③ After deciding the position and angle of the meter face, fasten the Hexagonal bolt on both sides to secure.
- *It is possible to install the Adjustable Stand in the reverse direction.

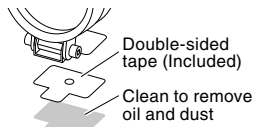
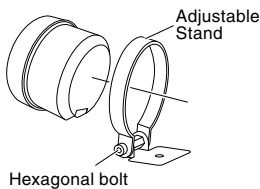

*Please be sure about where you wish to install the meter, as it is not advisable to reuse double-sided tape.

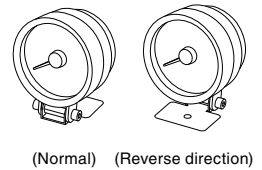
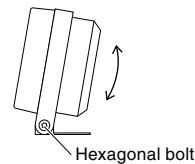

Mount into the Panel

- ① Wrap the cushion tape around the base of the meter.
- ② Press into the 60 mm hole in the panel.

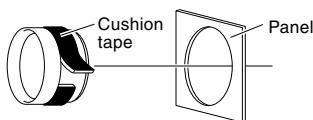

Meter Dimensions (unit; mm)

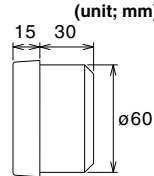

*If you wish to fasten the unit to the A-pillar or column cover, please purchase and use the separately sold meter holder which gives you installation a clean natural look. (For mounting to the A-pillar or other slanted surface, it is necessary to use screws.)

Mater Hood 60 (for ø60)
MH6-U (Multi-Purpose Type) ¥2,980
MH6-C (Processing Kit) ¥2,980

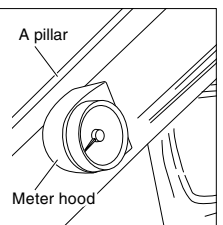

Installing The Unit

As shown in the right diagram, fasten the unit into positions not usually affected by water.

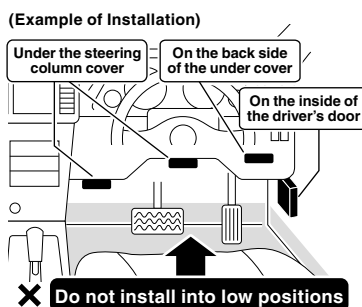



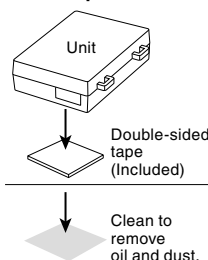

Fastening to Flat Space

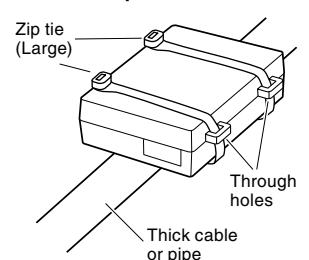

When Fastenings to a Cable or Pipe



Basic Operation

- 1 Key Switch ON** (Engine start) 
- 2 Opening Demo** 
- 3 Display Each Mode** 
- 4 Key Switch OFF** (Engine stop)
- 5 Meter OFF**  The needle stops when the key is turned OFF.

Opening Demo

- When the key is turned ON the needle will move to the extreme left several times for searching position. Then it will move to the maximum value and finally to reading for current measurement item.

Switching The Display

Switching The Digital Display

Press switch to change the multi-digital display in operation

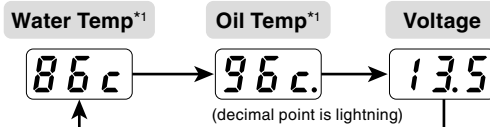

*1. Not displayed without temperature sensor.

Water Temperature / Oil Temperature Reading the Display

| | |
|--|------|
| -35 ~ -1°C | - 00 |
| The first place on the left shows "-" (minus). | |
| 0 ~ 99°C | 00 c |
| The third place from the left shows "C" (Celsius). | |
| 100 ~ 150°C | 100 |
| Numerical Value Only. | |

Display and Reset the Peak Value

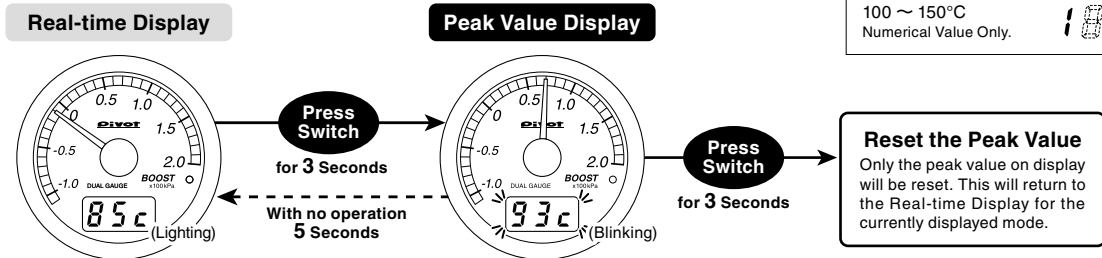

*Peak readings are reset when the key is turned OFF.

*For Boost, RPM, Water Temperature and Oil Temperature the high will be shown and for Voltage the low will be displayed.

*If you wish to check the loss of voltage upon operation of the starter, turn the key to the ON position and after the digital display comes on, operate the starter. However, Red code must be connected to the 12V IGN wire working with the starter operation and the key on.

Troubleshooting

| Trouble | Possible Causes | Possible Solutions |
|---|--|---|
| Does not work with Engine start. | Poor connection of Gauge cable , Red or Black wires. | Please reconfirm whether wiring and connections are correct or not. |
| The opening demo starts with Engine start, but the needle does not work. | Poor connection of the vacuum hose. | Please reconfirm whether wiring and connections are correct or not. |
| | Unable to measure pressure. | Please make sure to connect the hose which can measure pressure. |
| Upon starting up, the unit will not start in the newly changed display. | Because after changing displays, if the car's engine is turned off within 6 seconds, the new setting will not be stored, make sure to wait at least 6 seconds before turning the engine off. | |
| The displayed values are different from the standard meter. | This product's boost meter reads absolute pressure and may differ from a meter using relative pressure. | |
| The Temperature displays do not change from ---, or do not show the value with connecting the sensor. | Poor connection of Temperature sensor or breaking of wire. | Please reconfirm Temperature sensor and whether wiring and connections are correct or not. |

- ※Our products have already been recognized as our Industrial Property or are in the process of receiving Industrial Property status.
- ※We plan in the near future to take all possible legal measures to protect against unfair competition from look-alike products using similar designs, regulating characteristics, circuitry and circuitry layout.
- ※We strictly prohibit the unlicensed use of the PIVOT trademark and the unauthorized use of PIVOT User's Manual.