

One Type Analog Display coupled with Multi-Digital Display.

USER'S MANUAL

DUAL GAUGE

Easy Installation

Thank you for purchasing this PIVOT product.
Please read this manual carefully and keep it for future reference.

- If this product is given to another user, make sure to include this User's Manual.

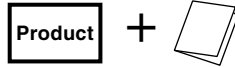

- BOOST+DIGITAL **DXB**
- VACUUM+DIGITAL **DXV**
- RPM+DIGITAL **DXT**
- RPM+DIGITAL For Hybrid cars **DXT-H**

Contents

Contents / WARNING / CAUTION 1
 Features 2
 Part Names 2
 Displays of each Products 2
 Connecting The Wires 2~3
 Installing The Product 3
 Basic Operation 4
 Switching The Display 4
 Troubleshooting 4

Please check the contents of the package

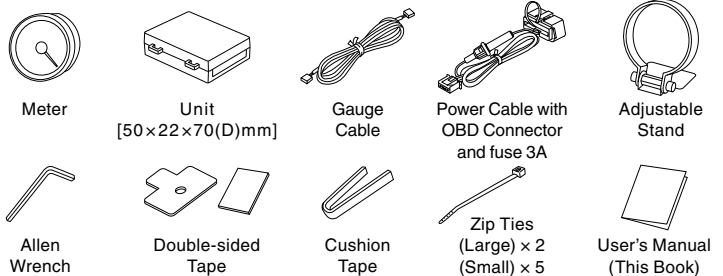

1. The display will not be proper if the ECU being used is not the standard one or if a sub-computer is being used, even in compatible car models.
2. Cannot be used in combination with other company's products that use Diagnostic Monitoring Connectors.

⚠ WARNING Improper use or disregard of these warnings may result in the injury or death of people.

- **Do not work in areas where there is excessive exhaust.**
Due to vehicle exhaust emission poisoning or fire may result in a damage to humans.
- **Do not crush the cable.**
Please be careful that the cable does not get crushed by the seat rail or car door steel plate, nor cut by any sharp steel plate as this may cause a poor connection or an electric short leading to fire or other danger.
- **Do not operate while driving.**
Operating or checking the display during driving may cause an accident; please use with the utmost consideration for safety.
- **Please securely fasten the product and be sure to store bundle away all wires with tape, etc...**
It is very dangerous to pull tangled wires by force or allow tangled wires to interfere with driving.

⚠ CAUTION Improper use or disregard of these warnings may cause injury to persons, damage the product and other things.

- **This product is for DC12V cars;**
Installation cannot be carried out on cars with other voltage batteries.
- **Just after installation do not exert any strong force on the product.**
When double-sided tape is used for an installation be warned that when hot the tape temporarily losses adhesiveness.
- **Do Not Use Chemical Cleansers.**
If the unit gets dirty please wipe with a soft cloth to remove any dirt. Do not use chemical cleansers such as thinner, benzene, or alcohol.
- **Do not install the product in any place subject to high temperature or any place where water may be splashed.**
- **Make sure to replace all screws and parts to their original place.**
- **Do not install the product in a place where it will cause distraction.**
- **Do not, in any manner, process, take apart, or make changes to this product.**

Features

Each of our Dual Gauges offer one type of analog display coupled with a multi-digit display in one smart looking unit, thus saving not only space but money.

Easy-to-Install Coupler Connection Models

The DX Series models provide easy installation by simply connecting to the diagnostic monitoring connector; this means being able to use the gauge without any extra necessary work.

Part Names

- 1 Analog Display** Display one type of data.
- 2 Needle** Shows the current values and peak value.
- 3 Switch** Use to change modes of digital display and reset the peak value.
- 4 Digital Display** Display switches between types.
- 5 Illumination (night illumination)** Normally illuminated when on display.

Analog Display	Dial : White, Needle : Red
Digital Display	Red (DXB/DXV/DXT) Green (DXT-H)

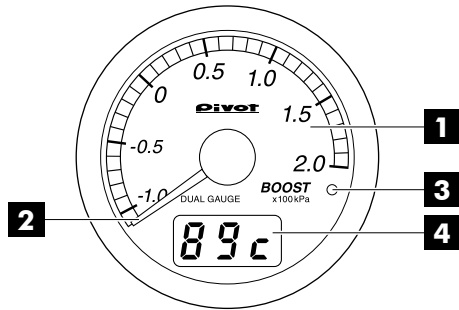

Displays of each Product

Display and Product Number				
	DXB	DXV	DXT	DXT-H
Analog Display [Display Range]	BOOST [-100 ~ 154 kPa]	VACUUM [-100 ~ 0 kPa]	RPM [0 ~ 9000 rpm]	RPM [0 ~ 7000 rpm]
Digital Display [Display Range]	Water Temperature and Voltage [Water Temp : -35 ~ 150 °C, Voltage : 8 ~ 18 V] Oil Temperature (Displayed with Sensor sold separately) [-35 ~ 150 °C]			

Connecting the Wires

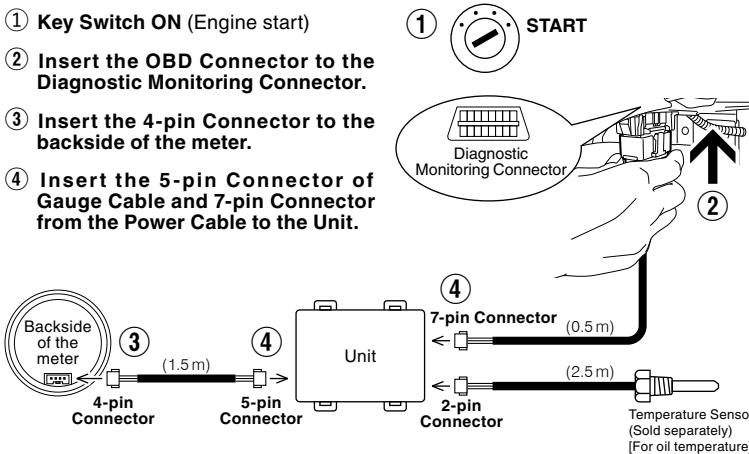

[Data] Placement Diagram for Diagnostic Monitoring Connector



TOYOTA	①②③④⑦	MAZDA	②④⑩
NISSAN	①②③④⑤⑦	SUBARU	②③
HONDA	②④⑤⑥⑧⑨	SUZUKI	②④
MITSUBISHI	②③④⑤	DAIHATSU	②③④⑤

- ① By the accelerator pedal
- ② At the right foot of the driver seat (with lid)
- ③ At foot of driver seat in the center
- ④ At the left foot of the driver seat (with lid)
- ⑤ At the right side of the center console
- ⑥ At the right foot of the passenger seat
- ⑦ Behind the panel by the steering (with lid)
- ⑧ At the left foot of the passenger seat
- ⑨ At the left side of the center console
- ⑩ Panel to right of steering wheel (upper part of small storage box)

2 Note that only after installation the unit must communicate the car and hence it may take approximately **1 minute** for the display to come on. From the second time, the display will take approximately 10 seconds to appear. *Same for reconnecting the OBD Connector.

[Reference] Notes about using the OBD Connector

Make sure to grip the distended portions when pulling it out or inserting it.

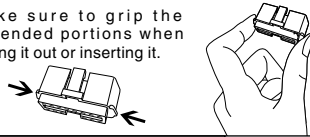

CAUTION
Do not pull on the wires when trying to remove the connector; the wires may become disconnected.

If you unable to get a grip on the distended portions.
In such case, pull out the connector by pulling on the end of the zip tie.

With some car models it may be difficult to get a good grip on the connector.

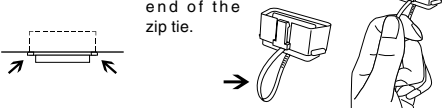

About Using OBD Products in Combination

If you wish to use **DUAL GAUGE** in combination with products in our 3-drive Series (**FLAT** or **COMPACT**), **PROGAUGE** the "OBD2 Wiring Kit OBD-EH" (sold separately) makes installation a snap.

For more details about using combinations of products see here.

<https://pivotjp.com/obd-e/>

*When using the **DUAL GAUGE** with products mentioned above, they can only be used together in compatible model vehicles for both products.

Connecting Oil Sensor

To display Oil temperature, you must purchase Temperature sensor (DTS) which is sold separately.

! Depending on the installation you may need a sensor adaptor. (sensor connector 1/8 PT sold separately)

Oil Drain Hole Installation

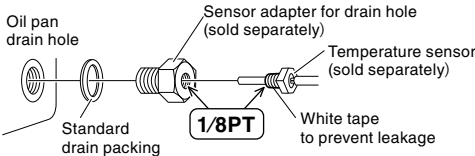

WARNING
For cars chassis that are low to the ground or in cases where road conditions may be poor, please do not use this type of installation. It may lead the sensor to bump against the ground and break or be damaged.

Oil Element Installation

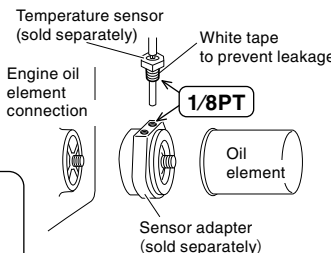

Installing The Product

Installation with the Adjustable Stand

Fasten using the double-sided tape. (On top of the steering column cover or dashboard.)

- Slightly loosen the Hexagonal bolt and install the gauge into the Adjustable Stand.
- Fasten using the double-sided tape. (Clean the surface; removing all oil and dust.)
- After deciding the position and angle of the meter face, fasten the Hexagonal bolt on both sides to secure.

*It is possible to install the Adjustable Stand in the reverse direction.

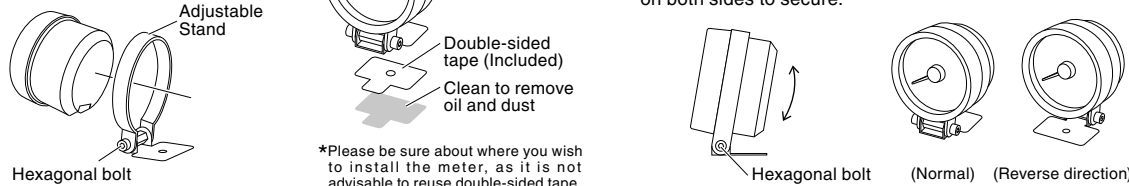

*Please be sure about where you wish to install the meter, as it is not advisable to reuse double-sided tape.

Mount into the Panel

- Wrap the cushion tape around the base of the meter.
- Press into the 60 mm hole in the panel.

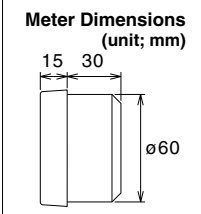
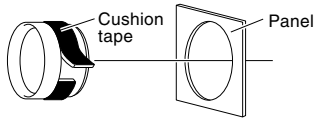

*If you wish to fasten the unit to the A-pillar or column cover, please purchase and use the separately sold meter holder which gives you installation a clean natural look. (For mounting to the A-pillar or other slanted surface, it is necessary to use screws.)

Mater Hood 60 (for ø60)
MH6-U (Multi-Purpose Type)
MH6-C (Processing Kit)

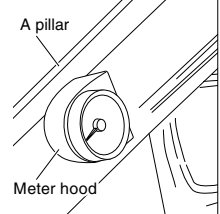

Installing The Unit

As shown in the right diagram, fasten the unit into positions not usually affected by water.

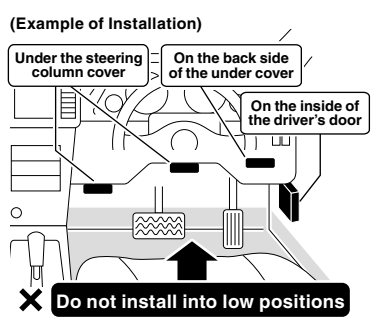



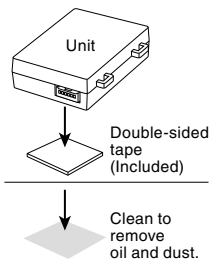

Fastening to Flat Space

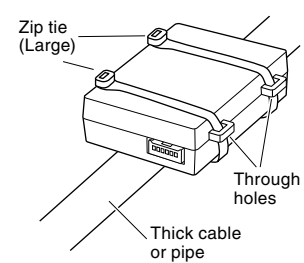

When Fastenings to a Cable or Pipe



Basic Operation

- 1 Key Switch ON** (Engine start) 
- 2 Opening Demo** 
- 3 Display Each Mode** 
- 4 Key Switch OFF** (Engine stop) 
- 5 Meter OFF**  The needle stops in the vicinity of lowest value.

Opening Demo

- When the key is turned ON the needle will move to the extreme left several times for searching position. Then it will move to the maximum value and finally to reading for current measurement item.
- Due to analysis time for the car data transmission it may take up to a few seconds from engine start before opening demo.

Turning off the Display

- Due to analysis time for the car data transmission, the illumination may remain on for up to 3 minutes even after the engine has been turned off; this is normal and no effect on the vehicle performance.

Switching The Display

Switching The Digital Display

Press switch to change the multi-digital display in operation

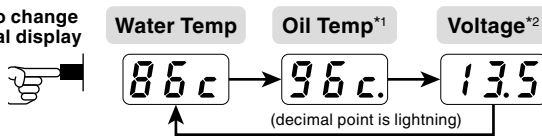

- *1. Not displayed without temperature sensor.
- *2. For some car models the voltage cannot be displayed or "--" will appear. For details, see the Fitting List.

Water Temperature / Oil Temperature Reading the Display

-35 ~ -1 °C	- 00
The first place on the left shows "-" (minus).	
0 ~ 99 °C	00 C
The third place from the left shows "C" (Celsius).	
100 ~ 150 °C	100
Numerical Value Only.	

Display and Reset the Peak Value

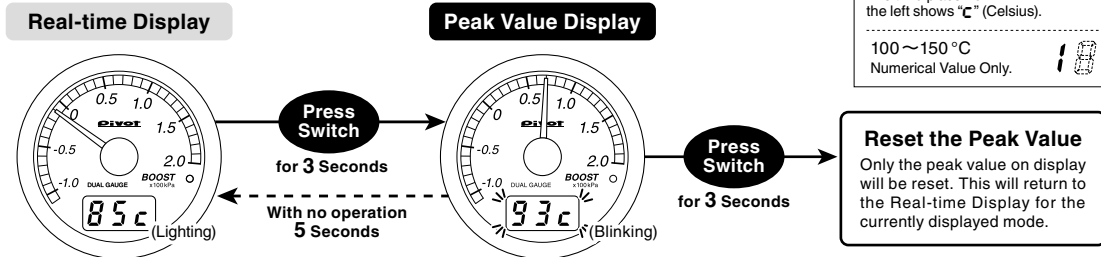

*Peak readings are reset when the key is turned OFF.

*For Boost, Vacuum, RPM, Water Temperature and Oil Temperature the high will be shown and for Voltage the low will be displayed.

*If you wish to check the loss of voltage upon operation of the starter, turn the key to the ON position and after the digital display comes on, operate the starter.

Troubleshooting

Trouble	Possible Causes	Possible Solutions
Does not work with Engine start.	Poor connection of Gauge cable , 7-pin Connector and OBD Connector .	Please reconfirm whether wiring and connections are correct or not.
	The unit has been installed into an incompatible car model.	Please check the "Fitting List".
	OBD Connector was connected when the key switch was set to OFF, or car battery was changed.	Connect again OBD Connector when the key switch is set to ON (engine start).
Upon starting up, the unit will start in the newly changed display.	Because after changing displays, if the car's engine is turned off within 3 seconds, the new setting will not be stored, make sure to wait at least 3 seconds before turning the engine off.	
Before the opening demo starts the needle briefly moves.	This is due to a special characteristic of the meter and is not a malfunction.	
The displayed values are different from the standard meter.	Due to the ECU information received, the displayed values on this product may differ from those of standard or other meters.	
	This product's boost meter reads absolute pressure and may differ from a meter using relative pressure.	
The key switch is set to ON, Needle of Boost / Vacuum shows minus value.	Absolute pressure sensor shows the value which subtracted atmospheric pressure. (Example : 700m above sea level = Minus 8kPa)	
The Oil Temperature displays do not change from ---, or do not show the value with connecting the sensor.	Poor connection of Temperature sensor or breaking of wire.	Please reconfirm Temperature sensor whether wiring and connections are correct or not.

※Our products have already been recognized as our Industrial Property or are in the process of receiving Industrial Property status.

※We plan in the near future to take all possible legal measures to protect against unfair competition from look-alike products using similar designs, regulating characteristics, circuitry and circuitry layout.

※We strictly prohibit the unlicensed use of the PIVOT trademark and the unauthorized use of PIVOT User's Manual.