

USER'S MANUAL

POWER MONITOR

0-100km/h TIME
WATER TEMP
VOLTAGE

Thank you for purchasing this PIVOT product.
Please read this manual carefully and keep it for future reference.

⚠ WARNING

Improper use or disregard of these warnings may result in the injury or death of people.

● Do not work in areas where there is excessive exhaust.

Due to vehicle exhaust emission poisoning or fire may result in a damage to humans.

● Do not crush the cable.

Please be careful that the cable does not get crushed by the seat rail or car door steel plate, nor cut by any sharp steel plate as this may cause a poor connection or an electric short leading to fire or other danger.

● Do not operate while driving.

Operating or checking the display during driving may cause an accident; please use with the utmost consideration for safety.

● Please securely fasten the product and be sure to store bundle away all wires with tape, etc...

It is very dangerous to pull tangled wires by force or allow tangled wires to interfere with driving.

⚠ CAUTION

Improper use or disregard of these warnings may cause injury to persons, damage the product and other things.

● This product is for DC12V cars;

Installation cannot be carried out on cars with other voltage batteries.

● Just after installation do not exert any strong force on the product.

When double-sided tape is used for an installation be warned that when hot the tape temporarily loses adhesiveness.

● Do Not Use Chemical Cleansers.

If the unit gets dirty please wipe with a soft cloth to remove any dirt. Do not use chemical cleansers such as thinner, benzene, or alcohol.

● Do not install the product in any place subject to high temperature or any place where water may be splashed.

● Make sure to replace all screws and parts to their original place.

● Do not install the product in a place where it will cause distraction.

● Do not, in any manner, process, take apart, or make changes to this product.

1. The display will not be proper if the ECU being used is not the standard one or if a sub-computer is being used, even in compatible car models.
2. Cannot be used in combination with other company's products that use Diagnostic Monitoring Connectors.
3. For details about using in combination with other PIVOT products that use Diagnostic Monitoring Connectors please see our Web Site at <http://pivotjp.com/obd-e/>.

Please check the contents of the package

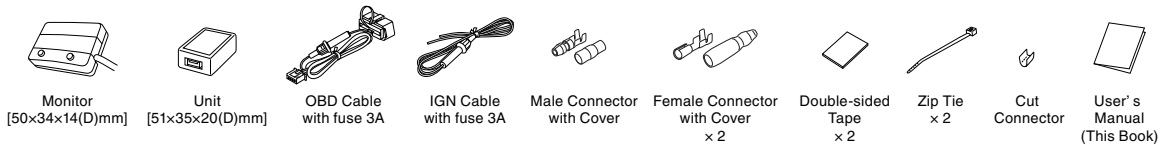

Features

Easy-to-Install, Automatically Measure 0-100km/h Time for Power check.

■ 0-100km/h Time

Automatically Measure 0-100km/h Time to set speed from stop.

Measurement speed=40/60/100(km/h)

*When measuring on public roads, observe the speed limit.

■ Multi-Data Display

Switch between 0-100km/h Time, Water Temperature and Voltage in the same unit.

■ Easy Installation

Simply connect to the diagnostic monitor connector.

■ Thin Compact Monitor

14mm Flat-Design allows for Unobtrusive Installation.

■ Peak Hold

The highest value of Water Temperature and the lowest value of Voltage will be displayed.

Part Names

1 Display

Display 0-100km/h Time, Water Temperature and Voltage.

2 PEAK/TIME Switch

Use to display and reset the peak value and measure the time.

3 MODE Switch

Use to change display modes.

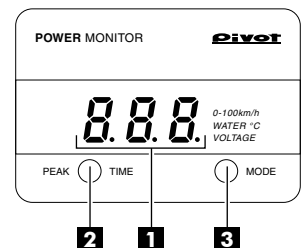

Connecting the Wires

- ① Insert the OBD Connector to the Diagnostic Monitoring Connector.
- ② Insert the 5-pin Connector from the Monitor and 7-pin Connector from the OBD Cable to the Unit.

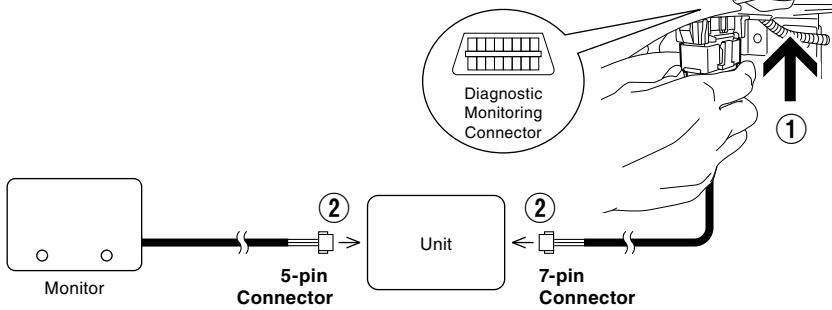

In case of installing in Euro car (BMW·MINI·AUDI)

● Change the power source from normal power of the Diagnostic Monitoring Connector to IGN.

IGN is "12V simultaneously with key ON" and "0V simultaneously with key OFF"

- ① Cut the **Red** cable of OBD Cable and insulated the cut off cable of OBD Connector side.

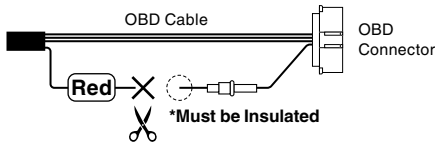

- ② Connect to IGN using the Cut Connector, Male and Female Connectors and IGN Cable as in the diagram below.

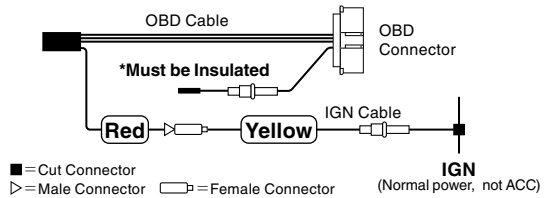

[Data] Placement Diagram for Diagnostic Monitoring Connector

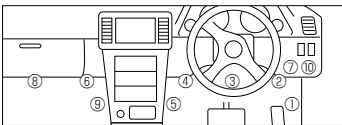

- ① By the accelerator pedal
- ② At the right foot of the driver seat (with lid)
- ③ At foot of driver seat in the center (with lid)
- ④ At the left foot of the driver seat (with lid)
- ⑤ At the right side of the center console
- ⑥ At the right foot of the passenger seat
- ⑦ Behind the panel by the steering (with lid)
- ⑧ At the left foot of the passenger seat
- ⑨ At the left side of the center console
- ⑩ Panel to right of steering wheel (upper part of small storage box)

TOYOTA	①②③④⑦	MAZDA	②④⑩
NISSAN	①②③④⑤⑦	SUBARU	②③
HONDA	②④⑤⑥⑧⑨	SUZUKI	②④
MITSUBISHI	②③④⑤	DAIHATSU	②③④⑤

[Reference 1] Notes about using the OBD Connector

Make sure to grip the distended portions when pulling it out or inserting it.



CAUTION

Do not pull on the wires when trying to remove the connector; the wires may become disconnected.

If you unable to get a grip on the distended portions.

In such case, pull out the connector by pulling on the end of the zip tie.

If you unable to get a grip on the distended portions.

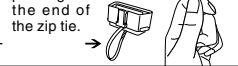

[Reference 2] How to use the Male Connectors

<p>1 Male sleeve Wire</p> <p>Pull the cable through the male sleeve.</p>	<p>2 10 mm</p> <p>Remove about 10 mm of the cable casing.</p>	<p>3</p> <p>Turn back the tip of the wires.</p>	<p>4 Male Connector</p> <p>Connect the male connector to the end of the cable.</p>	<p>5 Crimp these places</p> <p>Crimp down with crimpers to make sure that the inner wires are firmly connected to the inner part of the connector and that the cable section is connected to the outer part of the connector.</p>
<p>6</p> <p>Affix the male sleeve to the places as mentioned above.</p>	<p>NOTE: After connecting the male and female connectors, make sure to firmly twist the male sleeve inside the female sleeve.</p>			

[Reference 3] How to use the Cut Connectors

<p>1 10 mm</p> <p>Peel off of the vinyl cover at connection.</p>	<p>2 10 mm</p> <p>Peel off of the vinyl cover at the end of the product's wire.</p>	<p>3</p> <p>Wrap around both wire coils.</p>	<p>4</p> <p>Close tightly with cut connector.</p>	<p>5</p> <p>Insulate with vinyl tape.</p>	<p>When crimping, please use crimpers or use pliers to bend and then solder together.</p>
---	--	---	--	--	---

Installing the Product

● Installing the Monitor

Affix with double-sided tape to a position which is easy to see and which allows for easy operation.

(Example of Installation)

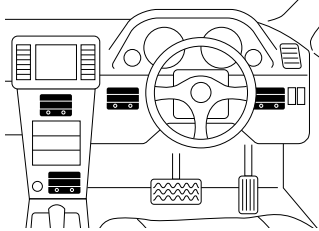

(How to Install)

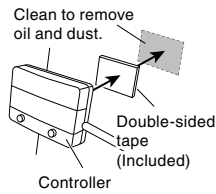

● Installing the Unit

As shown in the diagram below, fasten the unit into positions not usually affected by water.

(Example of Installation)

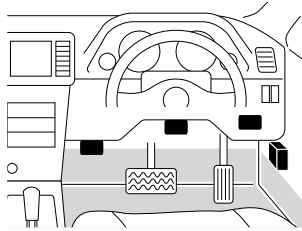

(How to Install)

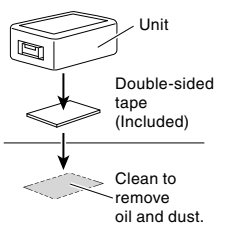

Please be sure to bundle away all wires with tape, etc...

While in use if wires become free they may interfere with driving and cause accidents. Also, wires which are smashed or crushed may result in a short and can be extremely dangerous.

Basic Operation

Due to analyzation time for the CAN data transmission it may take up to 5 seconds from engine start before the display lights up.

This product is interlocked with the ECU (engine computer) power. Depending on the model of car, the illumination may remain on for up to 3 minutes even after the engine has been turned off; this is normal.

Change Display Modes

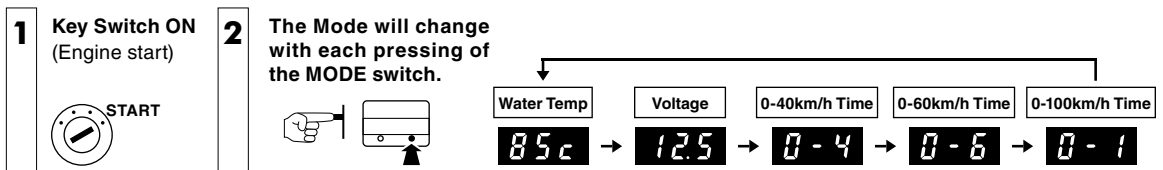

Display and reset the Peak Value (Water temp: ascending side / Voltage: descending side)

Peak reading display	Peak reading display	Measuring the lowest voltage by voltmeter
<p>1 Press the PEAK switch while displaying Water temp or Voltage</p>	<p>1 Press the PEAK switch for 3 seconds while displaying Peak Value</p>	<p>1 Turn the key switch ON and display the meter</p> <p>ON or ENGINE START STOP</p> <p>Without braking, press down twice</p>
<p>2 Peak reading display</p> <p>The Peak Value blinking.</p>	<p>2 Reset the Peak Value</p> <p>Blinking display changes to lighting.</p>	<p>2 Start the engine and check the lowest voltage with Peak reading display</p> <p>START or ENGINE START STOP</p> <p>With braking, press down once</p>
<p>3 Real-time display</p> <p>Back to real-time display after 3 seconds releasing the switch.</p>	<p>3 Real-time display</p>	<p>● Recommend to charge or replace the battery if it's lower about 1V or more than when new.</p>

※Each peak value can be reset by the key OFF.

Measuring the Time (0-40/60/100km/h Time)

*When measuring on public roads, observe the speed limit.

1 Stop the car on the place you want to start measuring the time

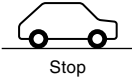

2 Press the MODE switch to chose mode to measure

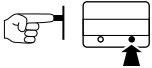

e.g.
0-100km/h Time



3 Press the TIME switch to ready to measure

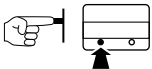

Ready



4 Automatically Measure when the car start driving
(Beep will sound 0.5 second)



5 Display the measured time when reach the set speed
(Beep will sound 1 second)



(e.g. 8 seconds 25)

Measure again

Press the TIME switch and see **4**

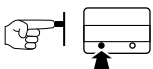

Change Mode

Press the MODE switch to change mode

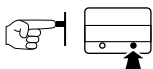



- If operate the switch after the measurement, the measurement data will be erased.
- The maximum time of measuring is 59 seconds 9.
- If the measuring time will be more than 59 seconds 9, the display will return to step **2**.
- If you stop the car while measuring, the display will return to step **2**.

Reading Display and Display Range

Water Temp Display Range: -35 to 150 °C
1 °C unit

-35 ~ -1 °C 0 ~ 99 °C 100 ~ 150 °C

The first place on the left shows "-" (minus). The third place from the left shows "C" (celsius). Numerical Value Only.

Voltage Display Range: 8 to 18 V
0.1 V unit



The second place from the left shows the "." (decimal point).



*Some car models cannot display Voltage. Check the "Fitting List".

Measuring the Time Display Range: 0 to 59 seconds 9

0 ~ 9 seconds 99 10 ~ 59 seconds 9

The first place on the left shows the "." (decimal point). Measuring 0 second 01 unit. The second place from the left shows the "." (decimal point). Measuring 0 second 1 unit.

Troubleshooting

Trouble	Possible Causes	Possible Solutions
Does not become ready in measuring the time.	The car is not stopped completely.	Stopped the car completely and press the TIME switch.
The measured values are different from the standard meter.	Standard Meter appears slightly higher (about 10km/h).	The display of this product is correct.
Upon starting up, the unit will start in the newly changed mode.	The car's engine is turned off within 3 seconds after changing modes.	Stop the car's engine after more than 3 seconds after changing modes.
Does not work with Engine start.	Poor connection of 5-pin Connector, 7-pin Connector or OBD connector.	Please reconfirm whether wiring and connections are correct or not.
	The unit has been installed into an incompatible car model.	Please check the "Fitting List".

- ※ Our products have already been recognized as our Industrial Property or are in the process of receiving Industrial Property status.
- ※ We plan in the near future to take all possible legal measures to protect against unfair competition from look-alike products using similar designs, regulating characteristics, circuitry and circuitry layout.
- ※ We strictly prohibit the unlicensed use of the PIVOT trademark and the unauthorized use of PIVOT User's Manual.