

PIVOT
STEPPING GAUGE

TACHO LAMP
(SGT-F1/F1G, F0/FOG)

USER'S GUIDE

Thank you for purchasing our PIVOT STEPPING GAUGE SERIES.
Please read these instructions carefully before installing or using this meter.

CONTENTS

Meter with (Shift Lamp)	Control Switch	Band Clamp (Already attached to Meter Unit)	Base Holder	Pillar Bracket	Double-sided Tapes (L) x3	Double-sided Tapes (S) x2
						Diagram Manual for each ECU type User's Guide
Allen Wrench	Philips Head Machine Screws with Flat Lock Washer (M5) X2	Hexagonal Washer Nuts (M5) x2	Tap Screws (Short) X2 (Long) X2	Wire Connectors x3	5-pin Coupler Cable	

FEATURES

■ Meter Unit

- The microcomputer equipped stepping motor drive gives you a highly precision display of engine revolutions.
- All settings are viewed on the meter as they are carried out.

■ Control Switch

This compact and lightweight unit allows you the freedom of choice to install almost anywhere.

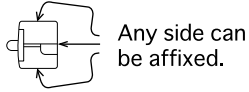

【Opening Demo】

By turning the key switch on, the meter lamp will flash on, the needle will move in a fixed pattern (search for 0), and the shift lamp will switch on.

【Demonstration Mode】

The unit is equipped with a demo mode for use on cars in shops and dealers. The needle and lamp will operate in a random fashion.

PART NAMES AND FUNCTIONS OF METER

METER INDICATOR

- Display Range 0 ~10,000rpm
- Opening Demo

- Operations Display
 - Shift-point Setting
 - Demonstration Mode
 - Peak Display & Reset

- Illumination
 - F1/F0=White LED Illumination.
 - F1G/FOG=Blue LED Permeating Illumination.
 - Linkage to Small Lamps.
 - Brightness Control Function.

⚠ The lamp will not come on if the key switch is ON and small lamps are OFF.

【SGT-F1/F1G】

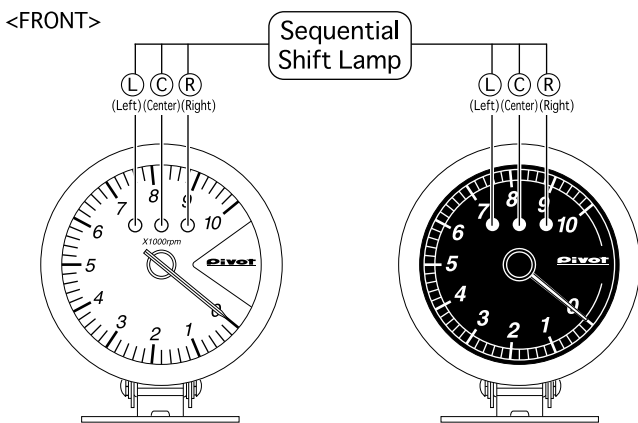

Sequential Shift Lamp

■ The meter is equipped with a sequential shift lamp (super high luminosity), which is designed to have the first lamp go off at 1000rpm before the set shift point, the first two lamps to go off at 500rpm before the shift point and all three lamps to blink at the shift point.

- Lamp Color=Red
- Setting Range=1,500 ~10,000rpm (in 100rpm units)
- Lamp lit ⇔ Lamp blinking can be changed.
- Brightness= Reduced brightness linked to small lamps. (Brightness can be set-see.)

⚠ In daytime, with small lamps off brightness cannot be changed.

■ Lighting Pattern

1,000rpm before setting (warning light)	○ ○ L lights up
500rpm before setting (warning light)	○ L and C light up
Reaches rpm setting (Shift Point)	All Lamps flash (or light up)

NOTE : The warning lights cannot be set to flash.

【SGT-F0/FOG】

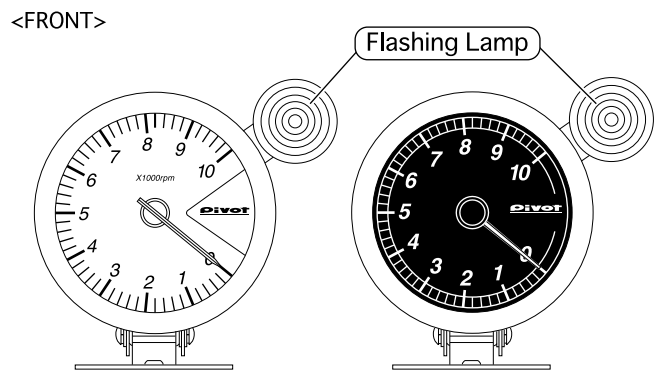

Flashing Lamp

■ Super high luminosity (4 LEDs) shift lamp, set in a large cutout aluminum body, can be set to switch on at desired engine revolution.

- Lamp Color=Red
- Setting Range=1,500 ~10,000rpm (in 100rpm units)
- Lamp lit ⇔ Lamp blinking can be changed.
- Brightness= Reduced brightness linked to small lamps. (Brightness can be set-see.)

⚠ In daytime, with small lamps off brightness cannot be changed.

<BACKSIDE>

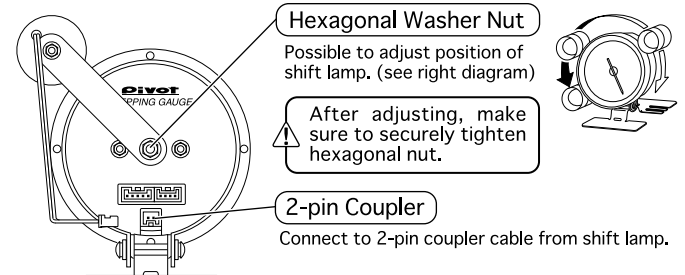

<SIDE>
Common

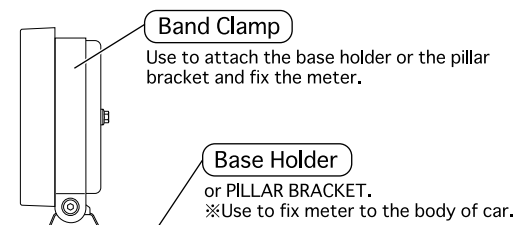

<BACK>
Common

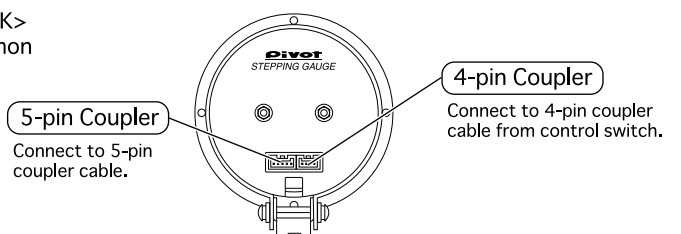

CONTROL SWITCH OPERATIONS SETTINGS (Settings and Verification)

WARNING

When carrying out these operations, make sure to park your car in a safe place. Trying to do these operations while the car is moving, may cause trouble and damage.

NOTE

After completing the settings please make sure to return to the normal display (complete the cylinder number setting procedure by pressing **PEAK** switch) before turning off the key switch.

USABLE ITEMS FOR EACH SWITCH

※For details, see each particular item.

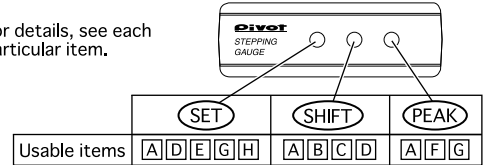

A Cylinder Settings

※Set to match the number of cylinders your car has.

●Check the cylinder number setting by counting the number times the shift lamp blinks.

[F1/F1G]
All 3 lamps blink.

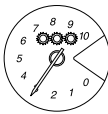

[FO/FOG]
The exterior shift lamp blinks.

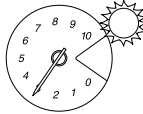

⚠ Be sure to adjust the cylinder number setting according to the table to the right after having made sure of the number of cylinders and cycles for the car in which you are installing. However, with some car models the settings may differ depending on the place you connect to the rpm signal.

① For NISSAN models with independent firing and the ignition coil connected to ⊖, make the cylinder setting 1. If you set at the number of cylinders the display will read: Display value / No. of cylinders. (Ex: For a 6-cylinder car with the setting at 6, the meter should regularly read 3,000rpm, but will be displayed as 500 rpm.)

② For Rotary engine cars, set the cylinder setting to 4.

③ For others, see the attached [Diagram Manual for ECU Type].

EXAMPLE OF BLINKING

※6-cylinder type setting (blinking 6 times)

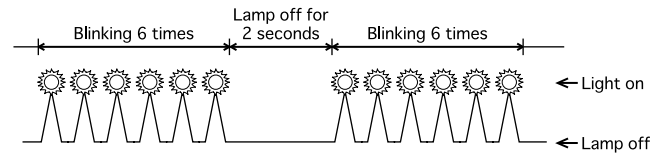

⚠ The default setting is set for 4-cylinder type. (blinking 4 times)

Cylinder No. Setting	1	2	3	4	5	6	8		
No. of Blinks	1	2	3	4	5	6	8		
No. of Cylinders	Independent firing	2	3	4	2	5	3	6	8
Cycles		4	4	4	2	4	2	4	4

HOW TO OPERATE

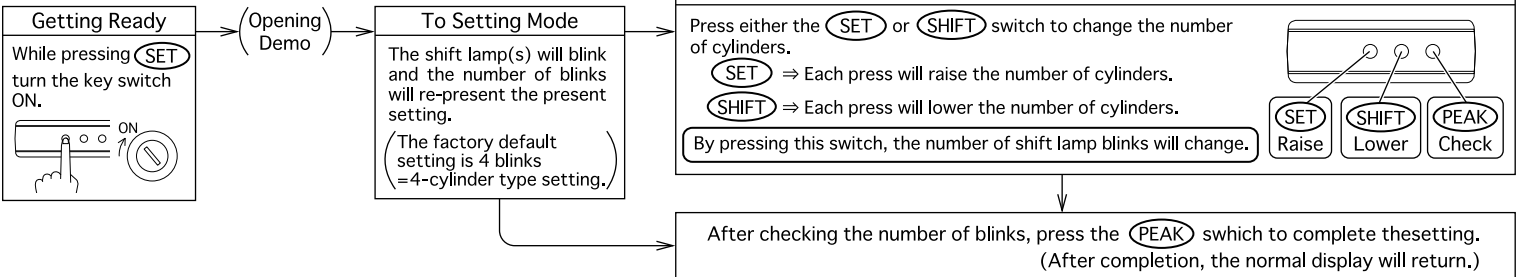

B Shift-point Settings

※Make rpm settings for when you wish the shift lamp to come on. (Range: 1,500-10,000 rpm)

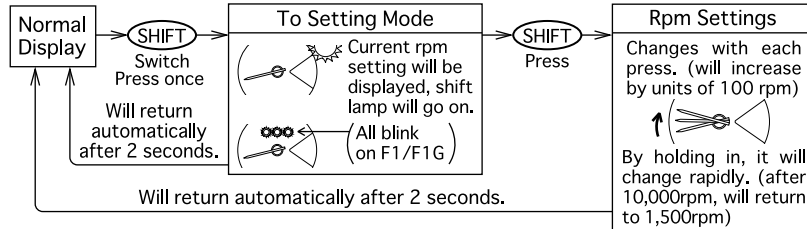

C Shift Lamp Lit ↔ Blinking Settings

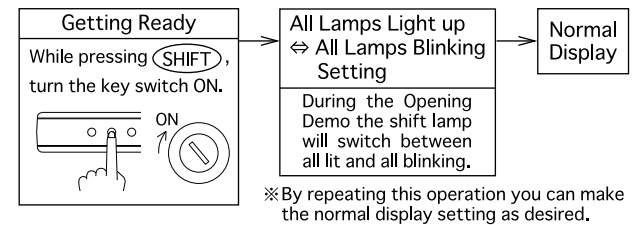

D Small Lamps ON: Brightness Settings

※Set the shift lamp brightness with the Small Lamps ON.

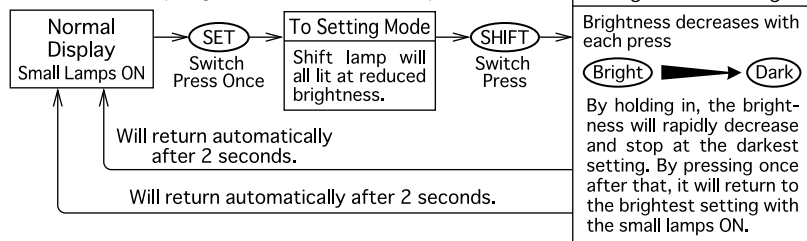

E Meter Brightness Settings

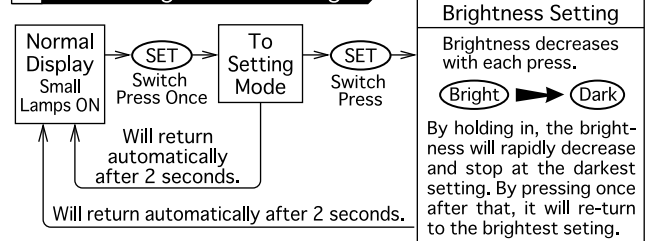

F Peak rpm Display and Reset

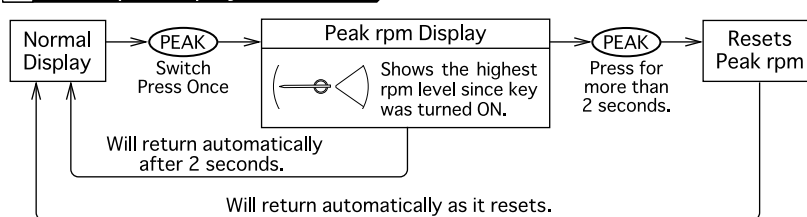

G Demonstration Mode Settings

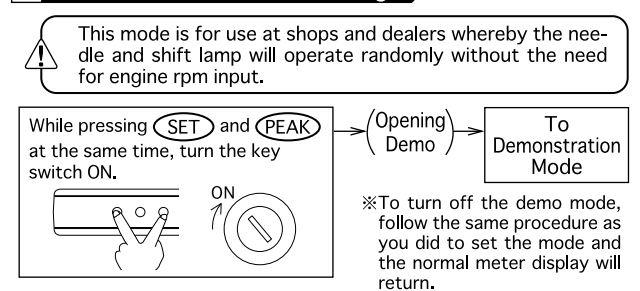

H Display Response Settings

This setting can be used with 4,5,6,8 cylinder settings to increase the display response speed.

NOTE: With 1,2,3 cylinder settings, changing this setting will make little or no difference in response speed.

NOTE: In cars with an unstable rpm signal, changing this setting to high response may result in a shaky or unstable needle.

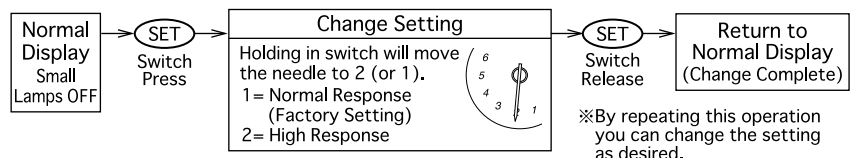

METER INSTALLATION

- There are 2 kinds of installation stands
- ⇒ Please use depending on installation place & condition.

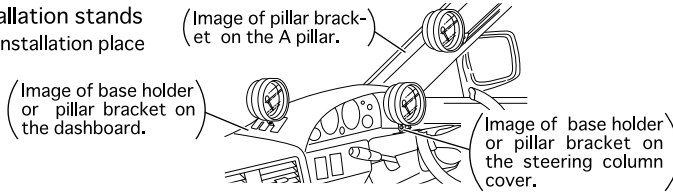

⚠ WARNING

- The pillar bracket must be used if attaching to the A pillar of car. If installed with double-sided tape, vibration may cause the meter to fall.
- Even if the meter is to be installed on the dashboard or steering column, it is best to use the pillar bracket and screws when possible.

A BASE HOLDER

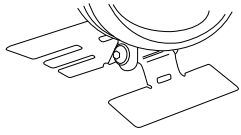

Used on sturdy places with double-sided tape.
Ex: on the steering column cover or dashboard, etc.

1. Installation with Base Holder

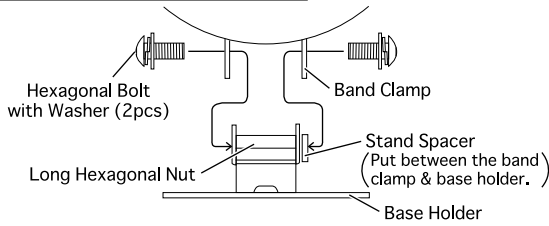

- Insert the long hexagonal nut inside the base holder.
- Put in the stand spacer between upper side of the band clamp & base holder (only one side).
- Temporarily fix with the hexagonal bolts.
- Put the meter into the band clamp.
- Firmly fix by tightening hexagonal bolts.

2. Attaching to Vehicle

⚠ WARNING

Never use double-sided tape which has already been used.
↓
Once used the tape adhesion becomes weak, increasing the possibility of falling.
↓
Carefully decide the place of installation before proceeding. You have done.

- Carefully decide installation place.
- Bend the stand to securely fit the place of installation.
- Clean the surface; removing all oil or dust.
- Fasten using the large double-sided tape.

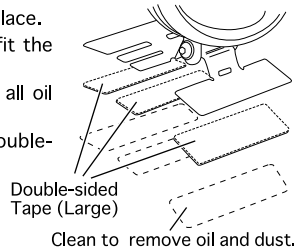

NOTE

If after installing the meter, the 5-pin coupler cable is viewable and looks bad.

↓
Tie the 5-pin coupler cable behind the meter with the zip tie.

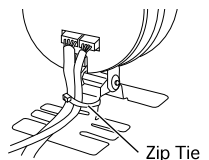

B PILLAR BRACKET

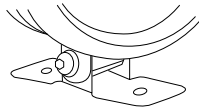

Used when fixing meter with screws on A pillar, etc.
(Use tapping screws or bolts & nut.)

1. Remove the Base Holder

⚠ WARNING

Make sure not to lose any removed parts. They will be needed to install the pillar bracket.

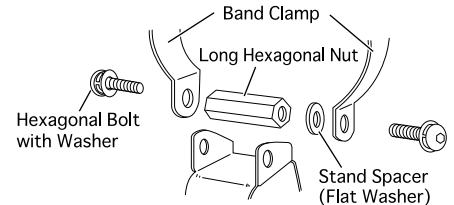

2. Installation with Pillar Bracket

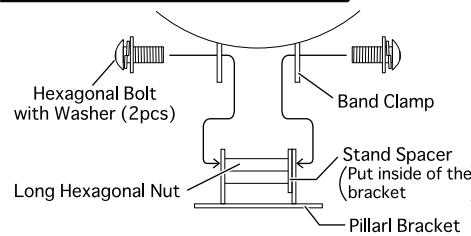

- Insert the long hexagonal nut and stand spacer inside the pillar bracket.
- Temporarily fix with the hexagonal bolts.
- Put the meter into the band clamp.
- Firm fix by tightening the hexagonal bolts.

3. Attaching to Vehicle

⚠ WARNING

Please check & confirm the strength, material, & thickness of the installation place. ⇒ Fix securely with tapping screws or bolts & nuts.

● If the installation place is made of steel plate,

it should be fixed with the short tapping screws.

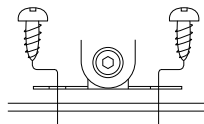

● If the steel plate is too thin.

⇒ Please reinforce it with another steel plate.

- Use a steel plate which is a little larger than the pillar bracket.
- Put it between the bracket and the installation place.

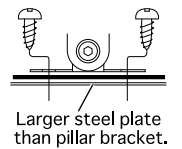

● If the installation place is removable.

⇒ Fix with bolts & nuts.

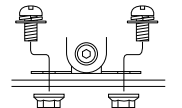

● If the installation place is made of plastic

Please check & confirm the strength, material, & thickness of the installation place and fix by bolts & nuts.

● If it seems of poor strength.

- Use a flat washer which is a little larger than a nut.
- Place the flat washer inside of plastic and fix with bolts & nuts.

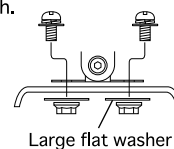

● If the pillar bracket can be fixed by penetrating to the inside of the steel plate.

⇒ Use the long tapping screws.

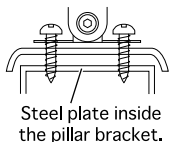

⚠ WARNING

Please check & confirm the strength, material, & thickness of the installation place.

⇒ If it is unstable, it may difficult to see the meter because of vibration.
⇒ In such a case, reinforce the stand by fastening it to a steel plate or by fixing it with tapping screws directly to a steel plate on the vehicle.

● Adjustment of meter angle.

- Loosen the hexagonal bolt.
- Adjust the angle to desired position.
- Firmly fasten in position by tightening bolt.

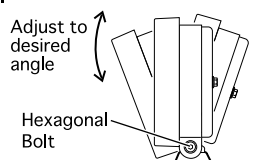

⚠ NOTE

(Only F0/F0G)

If shift lamp is too bright. ⇒ Adjust angle or position of shift lamp.

● How to affix the rear of the unit when installing into front panel.

Insert a long hexagonal nut and a flat washer between the arms of the band clamp and tighten it from the back to affix it.

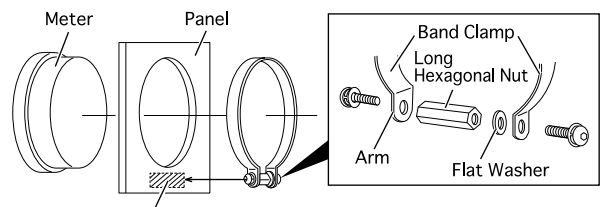

Use double-sided tape to hold the band clamp in place at the arms of the clamp.

CONNECTING THE WIRES

⚠️ INSTALLATION WARNING

1. Unless checking the connection, it is advisable to work with the minus \ominus terminal of the battery disconnected so as not to cause an electrical short.
2. Connect each part securely. (Imperfect connection may cause a malfunction.)
3. Insulate each connection properly. (A short circuit may cause a malfunction to your car or the meter.)
4. When laying wires be extra careful not to cut any wires or create short circuits.

BASIC WIRING

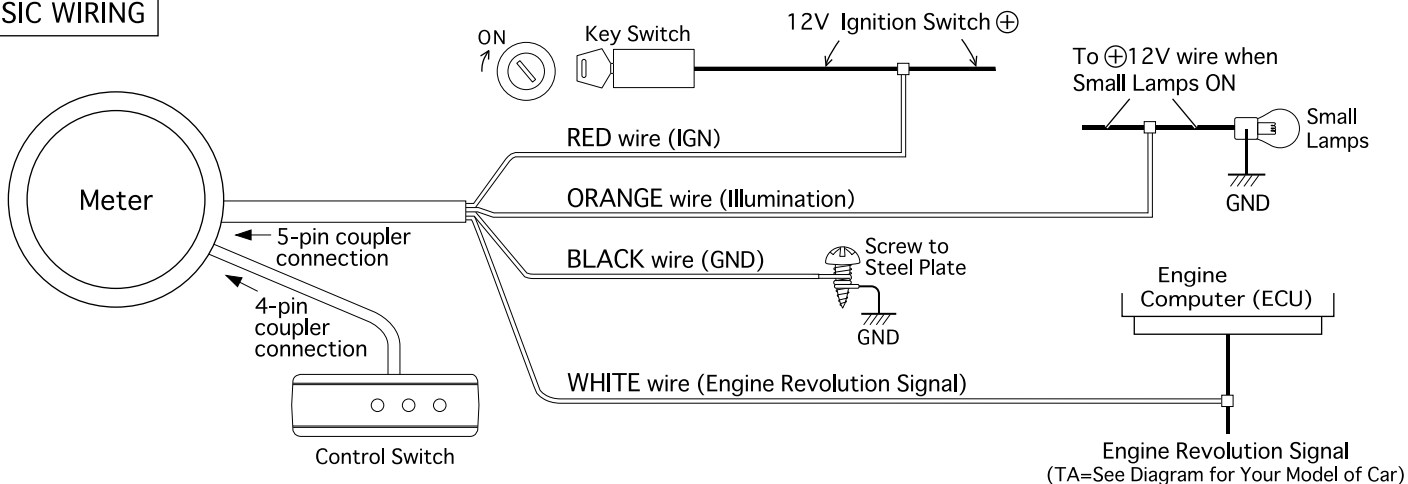

CONNECTION PROCEDURE

1. Securely connect each of the 4 wires from the 5-pin coupler cable.
 - RED wire (IGN) = Connect using a wire connectors to $\oplus 12V$ wire that runs to key switch ON.
 - ORANGE wire (Illumination) = Connect using a wire connectors to $\oplus 12V$ wire that runs to small lamps switch ON.
 - BLACK wire (GND) = Screw into steel plate of car body to obtain earth.
 - WHITE wire (Engine Revolution Signal) = Connect using a wire connectors to wire carrying revolution signal from engine computer. (TA in your car's Diagram.)
2. Connect the 5-pin coupler cable to the 5-pin coupler at the rear of the meter unit.
3. Connect the 4-pin coupler cable at back of control switch to the 4-pin coupler at the rear of the meter unit.

⚠️ WARNING

- When another device is already connected to the revolution signal from the ECU.
 - ⇒ and that device works properly keep that wiring.
 - ⇒ and the Meter or other device stops working properly or sometimes becomes unstable disconnect from the ECU wire and get the revolution signal from the \ominus terminal of ignition coil or diagnosis.
- When connecting the revolution signal to the ignition coil or diagnosis and the indicated rpm on the meter is obviously lower than actual rpm as shown on tachometer.
 - (Ex: For a 6 cylinder car, the reading should be 3,000rpm, but display shows 500rpm)
 - ↓
 - May be caused by the individual wiring system of that model of car.
 - ↓
 - Change cylinder setting to 1. See [Operations Settings **A**] for details.

⚠️ To get revolution signal from ignition coil use resistor wire included in kit.

◆ To get revolution signal from Diagnosis (check connector).

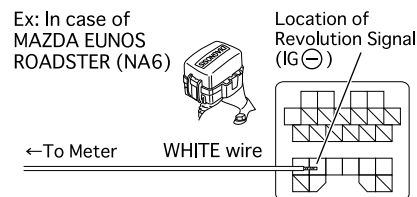

◆ To get revolution signal from Ignition Coil.

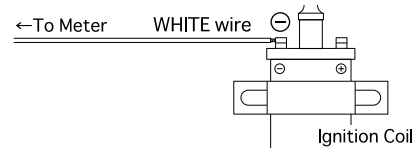

TROUBLESHOOTING

※ Please make the following checks before seeking repair.

Trouble	Possible Causes	Possible Solutions
Engine is running but tachometer doesn't work.	<ul style="list-style-type: none"> ● Contact failure of RED wire (IG$\oplus 12V$). ● Contact failure of BLACK wire (GND). ● Contact failure of WHITE wire (Revolution Signal). 	Check the wire connections or conditions.
	<ul style="list-style-type: none"> ● Contact failure of 5-pin coupler cable. 	Check the coupler connection.
The car's tachometer and SGT meter readings are very different.	<ul style="list-style-type: none"> ● The cylinder setting is wrong. (If the difference is small it may be a difference in tachometer precision.) 	See [Operations Settings A] and make any necessary changes.
The shift lamp does not light up.	<ul style="list-style-type: none"> ● The engine rpm has not reached the set shift point. 	See [Operations Settings B] and make any necessary changes in the rpm shift point.
	<ul style="list-style-type: none"> ● Contact failure of 2-pin coupler cable. 	Check the coupler connection.
Even with the small lamps ON, the meter light does not come on.	<ul style="list-style-type: none"> ● The key switch is not ON. ● Contact failure of ORANGE wire (Small Lamps ON $\oplus 12V$). ● The brightness is set at the darkest setting. 	Turn the key switch ON. Check the wire connections or conditions. See [Operations Settings D] and make any necessary changes to brightness.
With the key OFF, the needle does not rest on "0".	This is a special characteristic of the meter's movement and is not a malfunction. If it rests at "0" with key ON and engine stopped, during opening demo, then it is functioning properly.	

HOW TO USE THE WIRE CONNECTORS

※ If soldering is possible, please do so.

Method 1 Connecting a new wire to the middle of another wire.

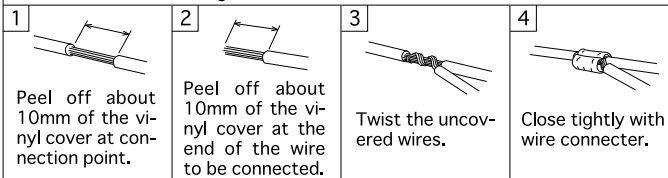

Method 2 Connecting two wires at their ends.

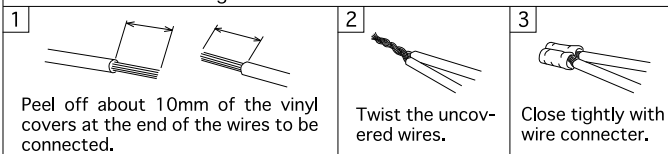

※ Use a crushing tool to press the wire connector. If you do not have such a tool, use pliers or such to fold and crush the connector together for a secure contact.

※ Loose connections can cause wire to come apart, so please make sure the connection is secure.

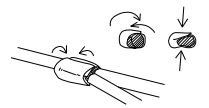

Be sure to insulate and secure with vinyl electrical tape.