

# PIVOT Super Temperature Controller STC User's Guide

## Contents of Kit

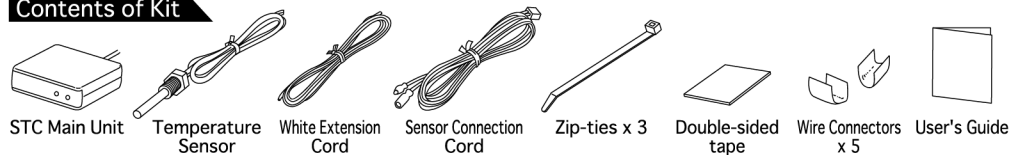

## Part Names and Functions

### Temperature Display

- Displays oil and water temp in 1 degree units ① Current Temp ② Peak Temp

Display Range: Water Temp (Engine Computer Connection) -20°C to 120°C  
 Water Temp (Sensor Connection) -35°C to 150°C  
 Oil Temp (Sensor Only) -35°C to 150°C

- Displays Fan Control Setting Temp (When setting only)

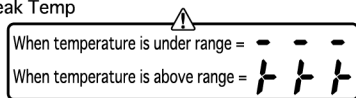

<FRONT>

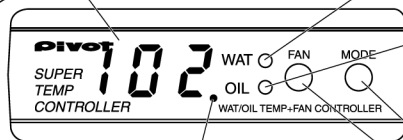

### Water Temp Monitor (Blue)

- When displaying water temp = ON
- When setting Fan Control Temp = Blinking

### Oil Temp Monitor (Red)

- When displaying oil temp = ON

(MODE) Switch

(FAN) Switch

Use for making settings and changes  
 ⚠ See [Method of Operation]

### Variable Display Monitor

When set for Variable Display light will be ON

<REAR>

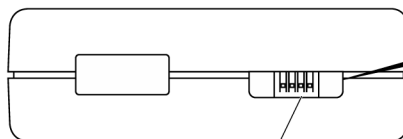

### Car Model Selection Switch

Change to fit your model car. ( See diagram at right)

⚠ Be sure to change this switch to match the make and model of car you are connecting to.

### WARNING

Due to the smallness of the car model selection switch be careful to use something with a sharp point (precision screwdriver, toothpick etc). (Be careful not to push too hard and force the switch into the inner part of the main unit)

(Top of Case)

	①	②	③	④
TOYOTA MAZDA	↓	↑	↑	↑
HONDA	↓	↑	↓	↑
NISSAN SUBARU (other than below)	↓	↓	↑	↑
IMPREZA (GDB, GGB, GDA, GGA) LEGACY(H13.5~BE5, BH5)	↑	↓	↑	↑
MITSUBISHI	↓	↓	↓	↑
⚠ Use with Temp Sensor	↓	↓	↓	↓

## Features

### ■ Dual meters for water and oil

- Water Temp: High precision by simply connecting to engine computer signal. (also able to connect to sensor)
- Oil Temp: Connect the included sensor for high precision measurement.
- Hold Peak Function: Display highest temp from engine start.
- Fixed or Variable Display: Choose from two ways (Fixed or Variable) to display readings.

### ■ Sequential Fan Control

- Allows you to change the operational temperature of the electric cooling fan in order to lessen gaps in temperature and better control for overheating and loss of power.
- In cars equipped with two fans, allows you to set them to kick on at 5 °C lower to give better and more stable water temperature control.

## Method of Operation

### 1] Setting for Fixed Display / Variable Display

- To make setting: push (FAN) and (MODE) switches at the same time.

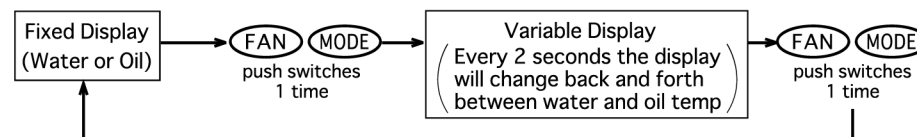

### 2] Fixed Display (Water or Oil) and Peak Display

- To make changes: While in Fixed Display, push (MODE) switch.

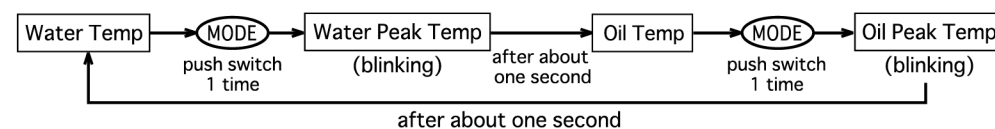

NOTE: From the Variable Display it is impossible to set the Fan Control Temperature. Even by pushing (MODE) switch, nothing will happen.

NOTE: The Peak Display cannot be held as a fixed display.

### 3] Setting for Fan Control Temperature

- To make setting: While in Fixed Display, push the (FAN) switch.

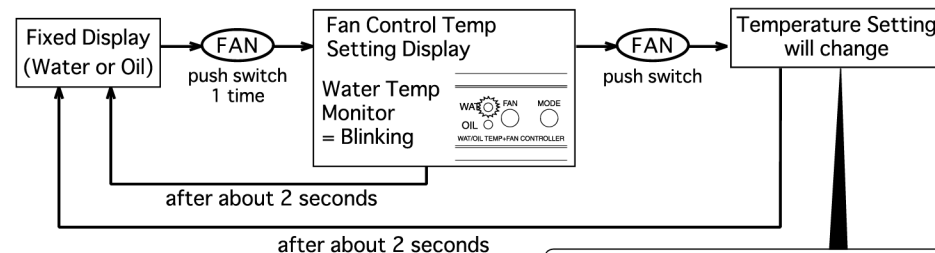

NOTE: If you wish to check the Fan Control Temp Setting, push the (FAN) switch once and it will be displayed, after which the normal display will return.

NOTE: From the Variable Display it is impossible to set the Fan Control Temperature. Even by pushing (FAN) switch, nothing will happen.

Change with each press of the (FAN) switch.

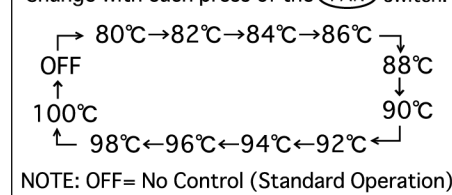

# WIRING PROCEDURE

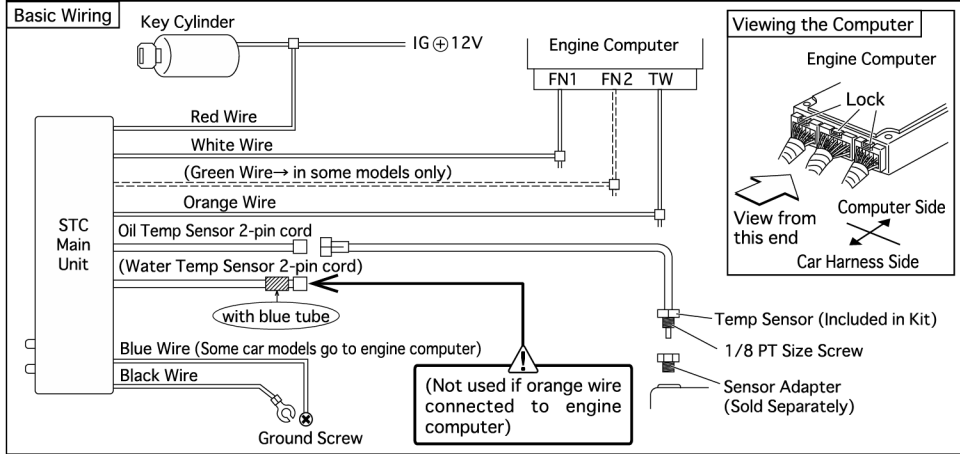

## Viewing the Computer

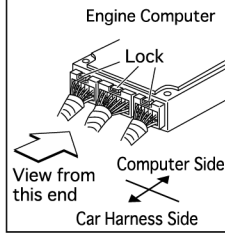

## Installation Warnings

1. Unless checking the connection, it is advisable to work with the minus  $\ominus$  terminal of the battery disconnected so as not to cause an electrical short.
2. Connect each part securely. (Imperfect connection may cause a malfunction.)
3. Insulate each connection securely. (A short circuit may cause a malfunction to your car or the STC Unit.)
4. When laying wires be extra careful not to cut any wires or create short circuits.

## Connection Procedure

Securely connect all wires coming out of the STC Main Unit

Red wire= Connect to  $\oplus$  12v wire that runs to Key Switch on.

White wire=Connect to electrical fan signal 1 of engine computer. (Please see wiring for your model of car =FN1.)

**NOTE** Depending on the model of car, you may have to use the white extension wire to connect to a designated spot other than the engine computer. For details see [Table of Wiring by Model of Car]

Green wire= For some model cars connect to the electrical fan signal 2 of the engine computer. ⇒(Please see [Table of Wiring by Model of Car-FN2]. If there are no specifics about this wire for your car, cut it and insulate.

Orange Wire= Connect to Engine Computer Water Temp Sensor [Table of Wiring by Model of Car-TW].

**NOTE** If you are connecting to a water temp sensor (included or sold separately), the orange wire is not needed. If not using, cut off and insulate.

Blue Wire= Screw into steel plate of car body to obtain earth.

**NOTE** If your car has specifications about connections for body earth (see Table of Wiring by Model of Car), do not connect the blue wire for earthing. Doing so may cause the temp display to be inaccurate or unstable.

Black wire=Screw into steel plate of car body to obtain earth.

Oil Temp Sensor 2-pin coupler cord=Use the included sensor connection cord to connect to the temp sensor.

**NOTE** Make sure the snap connector is firmly connected. In particular make sure the male side, which is the cover, is firmly inserted and screwed into the female side.

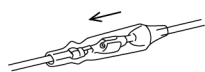

Water Temp Sensor 2-pin coupler cord(blue tube around coupler base) = If using a sensor to take water temp measurements, use the included sensor connection cord to connect to the temp sensor.

**NOTE**

1. If using the Orange Wire to connect to the computer temp sensor signal, there is no need to use this coupler cord.
2. If using this coupler cord, make sure to move all of the switches in the Car Model Selection Switch to the bottom. If this is not done the display will read - - - and the temp will not be displayed.

## INSTALLING THE SENSOR

Before installing the sensor please prepare the necessary sensor adapters and hose joints (1/8 PT size hole=sold separately) for the type of installation you will use.

### 1 OIL TEMPERATURE

#### A OIL PAN DRAIN HOLE INSTALLATION

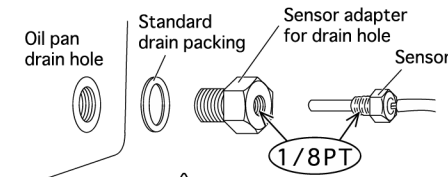

#### WARNING

For cars chassis that are low to the ground or in cases where road conditions may be poor, please do not use this type of installation. It may lead the sensor to bump against the ground and break or be damaged.

#### B OIL ELEMENT INSTALLATION

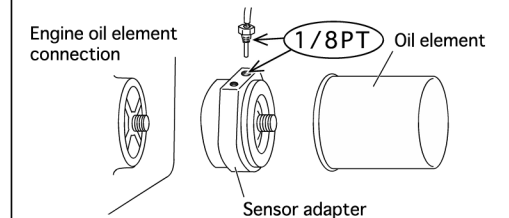

### 2 WATER TEMPERATURE

#### Attachment to the upper hose of radiator

1. Cut the upper radiator hose at a suitable spot.

(Water coolant will spill out, so prepare replacement coolant.)

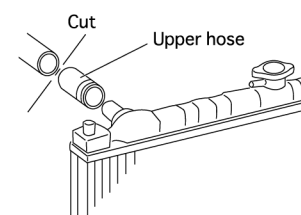

2. Fit the hose band onto the cut hose and securely connect the cut hose to the hose joint with the hose band, so as no leakage will occur.

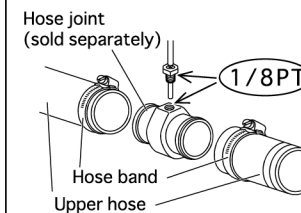

## NOTE ABOUT SENSOR

The white tape around the sensor screw is to prevent leakage; please screw on the adapter as is.

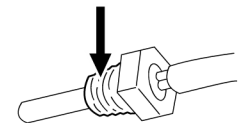

## INSTALLATION WARNINGS

1. Be sure to securely connect the sensor adapter and hose joint so as to prevent any leakage, and periodically check for leakage.
2. Carefully select the angle of the hose joint before you connect the sensor or the wire so as not to cause any sudden or drastic twists or bends.
3. Be careful not to carry out this installation while engine is hot; it may result in burns or injury. Make sure engine has sufficiently cooled down before attempting installation.

Please be sure to read and follow the instructions in the user's guide accompanying the sensor adapter and hose joint.

## How to use the Wire Connectors

※ If soldering is possible, please do so.

**Method 1 Connecting a new wire to the middle of another wire**

1 Peel off about 10mm of the vinyl cover at connection point.

2 Peel off about 10mm of the vinyl cover at the end of the wire to be connected.

3 Twist the uncovered wires.

4 Close tightly with wire connector.

**Method 2 Connecting two wires at their ends.**

1 Peel off about 10mm of the vinyl covers at the end of the wires to be connected.

2 Twist the uncovered wires.

3 Close tightly with wire connector.

※Use a crushing tool to press the wire connector. If you do not have such a tool, use pliers or such to fold and crush the connector together for a secure contact.

※Loose connections can cause wire to come apart, so please make sure the connection is secure.

**Be sure to insulate and secure with vinyl electrical tape.**



## Troubleshooting

\*\*Please make the following checks before seeking repair.

TROUBLE	POSSIBLE CAUSES	POSSIBLE SOLUTIONS
No display or illumination with key switched on.	<ul style="list-style-type: none"> <li>●Contact failure of red wire.</li> <li>●Contact failure of blue wire.</li> <li>●Contact failure of black wire.</li> </ul>	<ul style="list-style-type: none"> <li>●Check the wire connections or conditions.</li> </ul>
Water temp display shows - - -	<ul style="list-style-type: none"> <li>●Contact failure of orange wire</li> </ul>	<ul style="list-style-type: none"> <li>●Check the wire connections or conditions.</li> </ul>
	<ul style="list-style-type: none"> <li>●The orange wire is connected but the Car Model Selection Switch is set for sensor use.</li> </ul>	<ul style="list-style-type: none"> <li>●Change the Car Model Selection Switch to match the car you are using.</li> </ul>
	<ul style="list-style-type: none"> <li>●The sensor is defective (broken).</li> <li>●The sensor wiring is defective (poor connection/ broken)</li> </ul>	<ul style="list-style-type: none"> <li>●Check the condition of the sensor and / or cord.</li> </ul>
	<ul style="list-style-type: none"> <li>●A sensor is being used but the Car Model Selection Switch is not set properly.</li> </ul>	<ul style="list-style-type: none"> <li>●Check and change the Car Model Selection Switch to be set for [Use with Temp Sensor].</li> </ul>
Water temp display shows	<ul style="list-style-type: none"> <li>●The sensor is defective (broken).</li> </ul>	<ul style="list-style-type: none"> <li>●Check the condition of the sensor.</li> </ul>
	<ul style="list-style-type: none"> <li>●The temperature is above the displayable range</li> </ul>	<ul style="list-style-type: none"> <li>_____</li> </ul>
Oil temp display shows - - -	<ul style="list-style-type: none"> <li>●The sensor is defective (broken).</li> <li>●The sensor wiring is defective (poor connection / broken)</li> </ul>	<ul style="list-style-type: none"> <li>●Check the condition of the sensor and / or cord.</li> </ul>
	<ul style="list-style-type: none"> <li>●The temperature is below the displayable range</li> </ul>	<ul style="list-style-type: none"> <li>_____</li> </ul>
Oil temp display shows	<ul style="list-style-type: none"> <li>●The sensor is defective (broken).</li> </ul>	<ul style="list-style-type: none"> <li>●Check the condition of the sensor</li> </ul>
	<ul style="list-style-type: none"> <li>●The temperature is above the displayable range</li> </ul>	<ul style="list-style-type: none"> <li>_____</li> </ul>
Water or Oil temp display shows	<ul style="list-style-type: none"> <li>●The Car Model Selection Switch is set improperly.</li> </ul>	<ul style="list-style-type: none"> <li>●Check and Change the Car Model Selection Switch to match the car you are using.</li> </ul>
Oil or water temperature display suddenly changes. (Ex. Suddenly changes from 80°C to 100°C)	<ul style="list-style-type: none"> <li>●The electrical charge is unstable at connection point of red, blue or black wires.</li> </ul>	<ul style="list-style-type: none"> <li>●Change the point of connection.</li> </ul>
	<ul style="list-style-type: none"> <li>●The sensor wiring is defective (poor connection / broken)</li> </ul>	<ul style="list-style-type: none"> <li>●Check the condition of the sensor and / or cord.</li> </ul>
Electric fan doesn't work even if it reaches set temperature.	<ul style="list-style-type: none"> <li>●Contact failure of white wire.</li> </ul>	<ul style="list-style-type: none"> <li>●Check the wire connections or conditions.</li> </ul>
	<ul style="list-style-type: none"> <li>●Set temperature is OFF.</li> </ul>	<ul style="list-style-type: none"> <li>●Check the temperature setting.</li> </ul>
Electric fan starts to work before it reaches the set temperature.	<ul style="list-style-type: none"> <li>●When the set temperature is higher than the default temperature, the default setting takes precedence.</li> </ul>	<ul style="list-style-type: none"> <li>●Check the default temperature setting and then re-set the temperature.</li> </ul>
	<ul style="list-style-type: none"> <li>●Cars that have the green wire connected to the FN2, kick-in sequentially at 5 degrees lower than the set temperature.</li> </ul>	

STC (for USA)

**PIVOT CORPORATION**

87-3 OKADA SHIMO-OKADA MATSUMOTO-SHI NAGANO 390-0313 TEL0263-46-5901



**NOTE**

In the following cases, the temperature may exceed the set temperature; this is not a malfunction.

1. When the set temperature is too low. (Approx. less than 85°C)

2. When the external temperature is high.

3. When airflow to radiator or cooling is poor, as in traffic congestion or while stopped.