

USER'S MANUAL (Product Number: SWC-BM)

SEQUENTIAL WINKER CONTROLLER for BMW

Thank you for purchasing PIVOT product.

Please read this manual carefully and keep it for future reference.

If this product is given to another user, make sure to include this User's Manual.

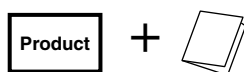

WARNING

Improper use or disregard of these warnings may result in the injury or death of people.

- **Do not work in areas where there is excessive exhaust.**
Due to vehicle exhaust emission poisoning or fire may result in a damage to humans.
- **Do not operate while driving.**
Operating and checking during driving may cause an accident; please use with the utmost consideration for safety.
- **Do not crush the cable.**
Please be careful that the cable does not get crushed by the seat rail or car door steel plate, nor cut by any sharp steel plate as this may cause a poor connection or an electric short leading to fire or other danger.
- **Please securely fasten the product to a stable place and be sure to store bundle away all wires with tape, etc...**
It is very dangerous to pull tangled wires by force or allow tangled wires to interfere with driving.

CAUTION

Improper use or disregard of these warnings may cause injury to persons, damage the product and other things.

- **Just after installation do not exert any strong force on the product.**
Please note that it's easy to unstick just after fixing the product with double-sided tape.
- **Do Not Use Chemical Cleansers.**
If the unit gets dirty please wipe with a soft cloth to remove any dirt. Do not use chemical cleansers such as thinner, benzene, or alcohol.
- **Do not install the product in any place subject to high temperature or any place where water may be splashed.**
- **Make sure to replace all screws and parts to their original place.**
- **Do not, in any manner, process, take apart, or make changes to this product.**



1. If you are worried about carrying out wiring or other installation procedures please consult your dealer.
2. We do not have any responsibility for any troubles caused by mistake or poor connection.

Contents

WARNING / CAUTION / Contents 1

Features 1

Part Names 1

Connecting The Wires 2

Adjusting Level 2

Fastening The Unit 2

Wiring of Each Vehicle Type and the Unit Installing examples 3

Troubleshooting 4

Please check the contents of the package

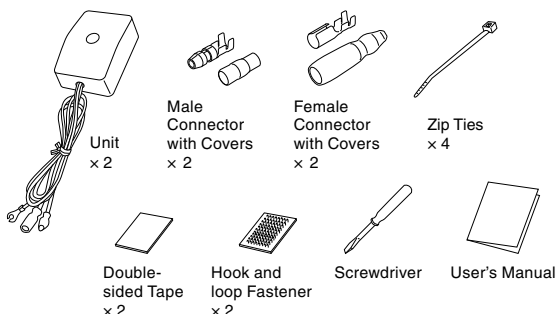

Tools and Materials to prepare for Installation

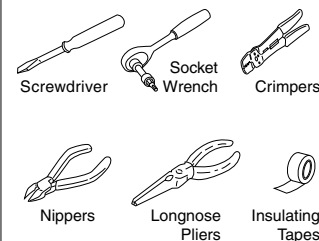

Features

Bringing Flow Control to Next Generation Turn Signals

- Make the Turn Signal light flowing by delaying the turn-on of the outer side Turn Signal.

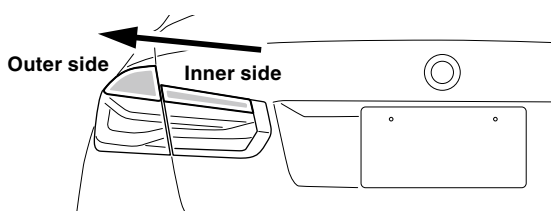

- Micro-computer control for stable operation not affected by temperature and voltage flux.
- 10-step adjustment from normal down to 0.1 seconds time lag.
- Compact size: 35 x 51 x 23 mm
- Meets safety standards for Japan's Road Trucking Vehicle Law.

Part Names

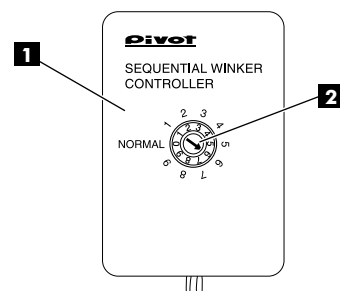

- 1 Unit
- 2 Adjustment dial
For lighting time lag adjustment of outer side Turn Signal

Connecting The Wires

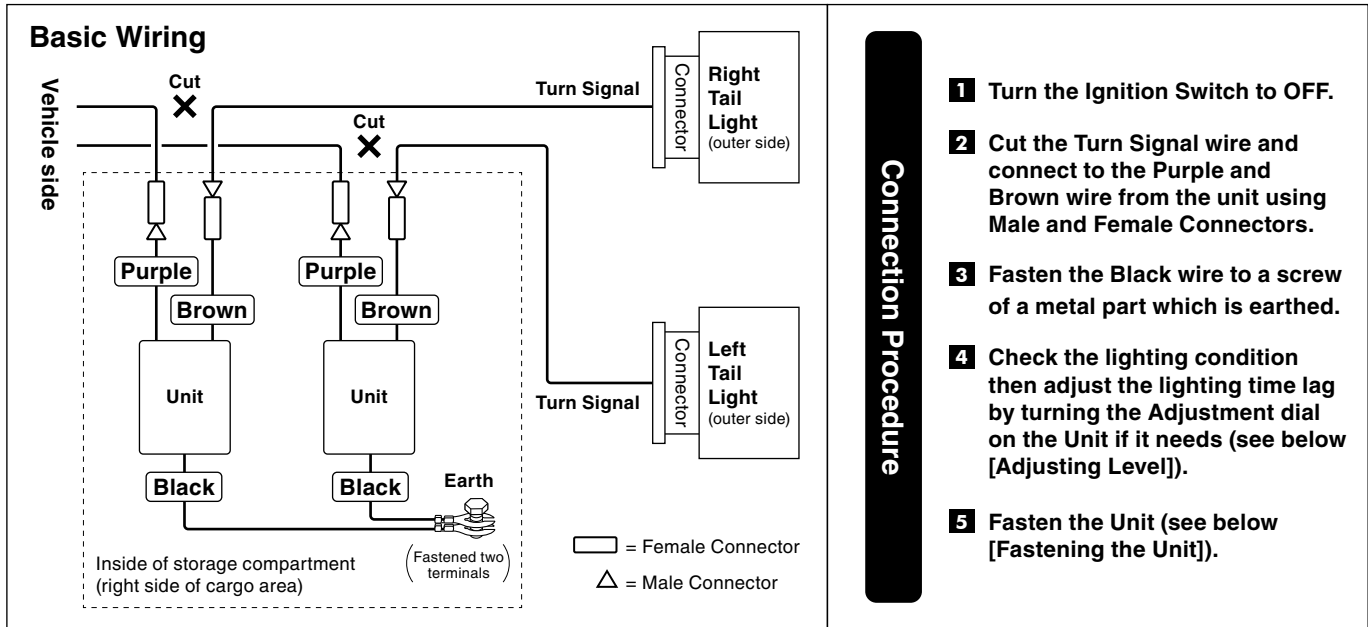

Turn Signal

- Purple** Connect to vehicle side of Turn Signal.
 - Brown** Connect to Tail Light side of Turn Signal.
- Turning on the Turn Signal to find the wire which is 12V with Lamp ON and 0V with Lamp OFF. Then connect it by using included cut connector.**

Earth

- Black with earth terminal** Fasten to a screw of a metal part which is earthed.
- Note: Painted screws and screws connected to plastic parts are not earthed; make sure to connect only to a place which is earthed.

[Reference] How to use the Male Connectors

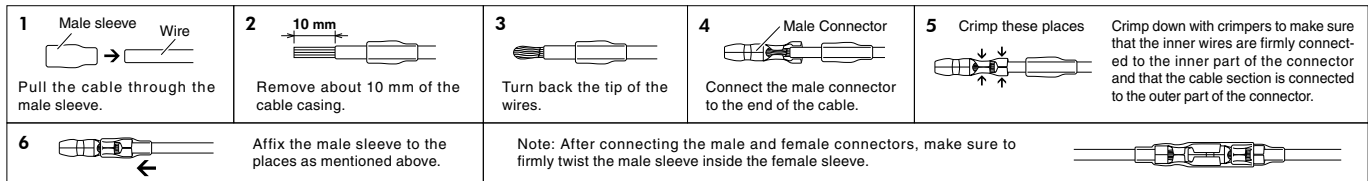

Adjusting Level

Turning the dial of the unit to adjust the lighting time lag of the outer side of Turn Signal.

Check the lighting time lag with turning on the hazard lights and make sure to set the value of the adjustment dial of the left and right to the same.
Note: Recommended value is from 6 to 9.

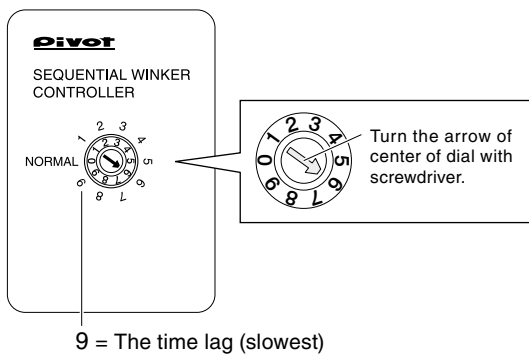

Fastening The Unit

Fasten the unit into positions either easy to adjust and not usually affected by water with using included Double-sided Tape or Hook and loop Fastener on the back side of the unit.

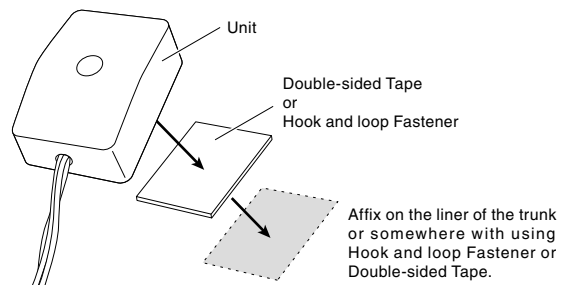

Dial	0	1	2	3	4	5	6	7	8	9
Time lag (x 0.01 sec.)	Normal Genuine state	2	3	4	5	6	7	8	9	10

The time lag is the time until the outer side Turn Signal lights up after the inner side Turn Signal lights up.

Wiring of Each Vehicle Type and Unit Installing examples

BMW F30/F31

Note: following example image is a case of sedan.

- 1 Remove the storage compartment on the right side in the cargo area and check the wire entrance point.

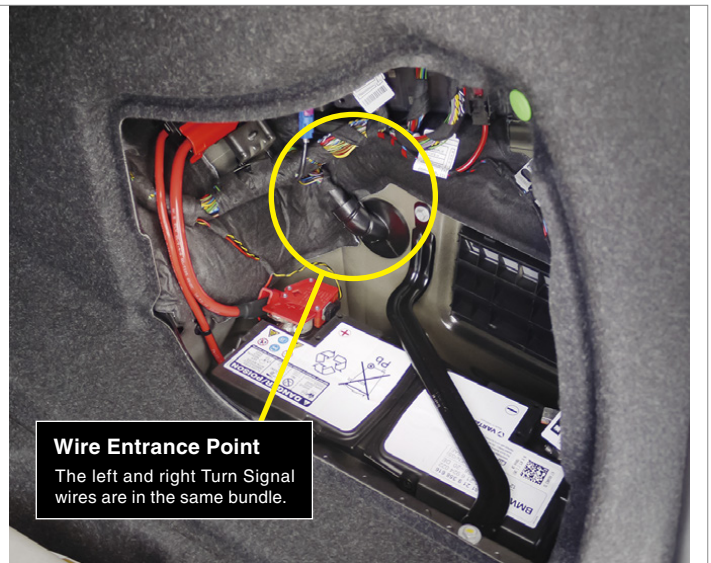

- 2 Remove the outer side Tail Light.
Note: Necessary for the left and right Tail Lights.



- 3 Pull off the connector of the Tail Light and make sure the color of the Turn Signal wire.

Note: Necessary for the left and right Tail Lights.



(View from the wire side)

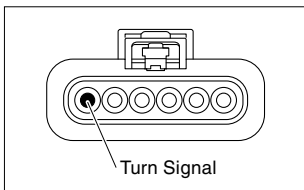

- 4 Find the same color wire from the bundle of wires in the 1 and make wiring by using included wiring parts (see page 2 [Basic Wiring]).

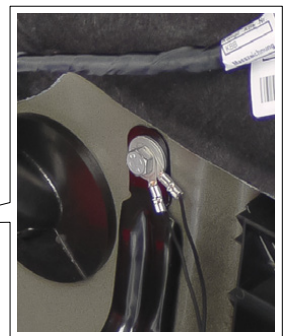
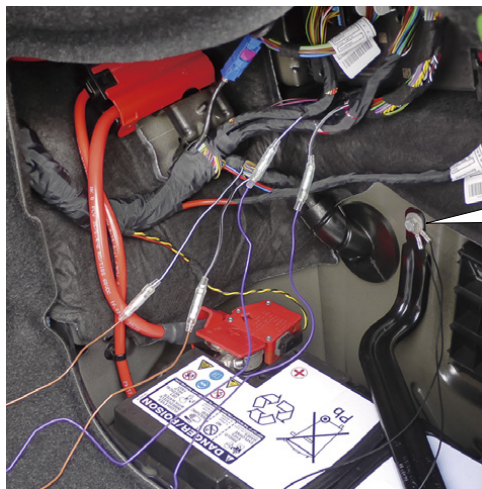

Fasten the Black wire to a screw of a metal part which is earthed. (Fastened two terminals)

- 5 Make wiring of the other side Tail Light, then adjust the time lag of the outer side Turn Signal lighting (see page 2 [Adjusting Level]).

- 6 Fasten the unit into positions either easy to adjust and not usually affected by water (see page 2 [Fastening the Unit]).

Troubleshooting

Trouble	Possible Causes	Possible Solutions
Tail Light does not light.	Poor connection of Purple , Brown and Black wires.	Please reconfirm wiring and connections of Purple , Brown and Black wires .
The time lag has not changed.	Adjustment Dial is set to 0. (0=Normal state)	Please reconfirm Adjustment Dial .

(Note)

- Our products have already been recognized as our Industrial Property or are in the process of receiving Industrial Property status.
- We plan in the near future to take all possible legal measures to protect against unfair competition from look-alike products using similar designs, regulating characteristics, circuitry and circuitry layout.
- We strictly prohibit the unlicensed use of the PIVOT trademark and the unauthorized use of PIVOT User's Manual.